

Life Is On

Schneider
Electric





 PriceList

Switching and Controlling Products

With effect from January 25th, 2022



se.com/in

EasyPact TVS	
> EasyPact TVS Power Contactors (3 Pole)	06
> EasyPact TVS Power Contactors (4 Pole)	07
> EasyPact TVS Contactor Accessories.....	08
> EasyPact TVS Thermal Overload Relay.....	09
> EasyPact TVS Circuit Breaker for Motor Protection.....	10
TeSys Control	
> TeSys K Control Relays	16
> TeSys K Power Contactors	16
> TeSys K Accessories.....	17
> TeSys Deca Control Relays 	18
> TeSys Deca Power Contactors (3 Pole).....	18
> TeSys Deca Power Contactors (4 Pole).....	19
> TeSys Deca Green 	20
> TeSys Deca Green Electric Coil Contactor 	21
> TeSys Deca Accessories.....	22
> TeSys Giga Power Contactors.....	29
> TeSys F Power Contactors	30
> TeSys F - Accessories	31
> TeSys Special Purpose Contactor.....	33
> TeSys H Ultra compact.....	34
TeSys Protect	
> TeSys Overload Relay	37
> TeSys Electronic Over Current Relay	39
TeSys Power	
> TeSys Motor Circuit Breakers	42
> GV4LE	43
> GV4PE	43
> Accessories for GV4.....	44
> Auxiliary Contact Blocks	44
> Circuit Breakers for Motor Protection Accessories	45
TeSys Switches	
> TeSys Switches.....	49
TeSys Active	
> TeSys island	51
> TeSys U	54
> TeSys T - iMCC Relays	58
TeSys Starters	
> Enclosed Starters.....	59
Selection Table	
> Type 2 Co-ordination Charts	60 to 65
> Type 2 Co-ordination chart with TeSys Giga range 	66 to 70
> Type 2 Recommended Selection Charts	71 to 77

For details on non standard references, technical parameters, accessories, compatibility, stockable and non stockable status please contact Customer Care

 NORMAL STOCK ITEMS

W.E.F. January 25th, 2022

EasyPact TVS

The Easy choice for simplicity and flexibility

- 3 Pole and 4 Pole Power Contactor
- Control Relays
- Thermal Overload Relay
- Circuit Breaker for Motor Protection
- Accessories

New

A2L certified
upto 50A
for HVAC
applications

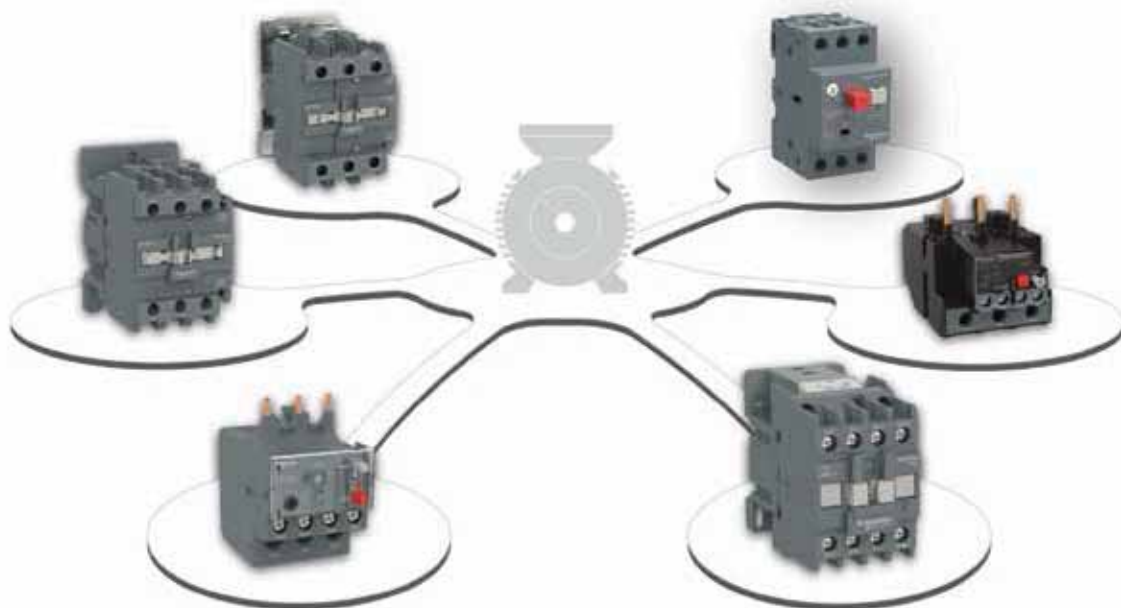

EasyPact TVS
Catalogue

Designed for the Essential



Selection Charts for
Motor Feeders for
IE2/IE3 Motors with
EasyPact TVS

W.E.F. January 25th, 2022

EasyPact TVS

Power Contactors - ETVS (3 Pole AC Control)



- Conformance to IEC 60947-4-1, CE Marking
- Current Rating: 6A to 630A, AC-3 Rating
- Type 2 RSC available with Fuse, MPCB and MCCB

Frame	[le] Rated Operational Current		Motor Power at 415V, 3Ph, 50Hz		Auxiliary Contacts		Reference	Unit MRP [₹]
	AC-1	AC-3	HP	kW	NO	NC		
FRAME-1	20	6	3	2.2	-	1	LC1E0601* <input checked="" type="checkbox"/>	1190
					1	-	LC1E0610* <input checked="" type="checkbox"/>	
	25	9	5.5	4	-	1	LC1E0901* <input checked="" type="checkbox"/>	1220
					1	-	LC1E0910* <input checked="" type="checkbox"/>	
	25	12	7.5	5.5	-	1	LC1E1201* <input checked="" type="checkbox"/>	1390
					1	-	LC1E1210* <input checked="" type="checkbox"/>	
32	18	12	9	-	1	LC1E1801* <input checked="" type="checkbox"/>	1605	
				1	-	LC1E1810* <input checked="" type="checkbox"/>		
36	25	15	11	-	1	LC1E2501* <input checked="" type="checkbox"/>	2190	
				1	-	LC1E2510* <input checked="" type="checkbox"/>		
FRAME-2	50	32	20	15	-	1	LC1E3201* <input checked="" type="checkbox"/>	4585
					1	-	LC1E3210* <input checked="" type="checkbox"/>	
	50	38	25	18.5	-	1	LC1E3801* <input checked="" type="checkbox"/>	5420
					1	-	LC1E3810* <input checked="" type="checkbox"/>	
50	40	29	22	-	1	LC1E40B01**	5780	
				1	-	LC1E40B10**		
FRAME-3	60	40	29	22	1	1	LC1E40* <input checked="" type="checkbox"/>	7180
					1	1	LC1E50* <input checked="" type="checkbox"/>	
	70	50	34	25/30	1	1	LC1E50* <input checked="" type="checkbox"/>	8730
80	65	50	37	-	-	LC1E65* <input checked="" type="checkbox"/>	11830	
				1	1	LC1E65* <input checked="" type="checkbox"/>		

Frame	[le] Rated Operational Current		Motor Power at 415V, 3Ph, 50Hz		Auxiliary Contacts		Reference	Unit MRP [₹]
	AC-1	AC-3	HP	kW	NO	NC		
FRAME-4	110	80	60	45	1	1	LC1E80* <input checked="" type="checkbox"/>	15380
	120	95	60	45	1	1	LC1E95* <input checked="" type="checkbox"/>	18440
FRAME-5	150	120	75	55	1	1	LC1E120*	21965
	200	160	120	90	1	1	LC1E160*	29005
FRAME-6	250	200	150	110	-	-	LC1E200*	39920
	300	250	175	132	-	-	LC1E250*	52610
FRAME-7	320	300	215	160	-	-	LC1E300*	62980
	500	400	295	220	-	-	LC1E400*	78600
FRAME-8	700	500	375	280	-	-	LC1E500*	110710
FRAME-9	1000	630	500	375	-	-	LC1E630*	157180

* Reference to be completed by adding coil voltage code and recommended to check availability with Customer Care team

Spare Coil for Contactors

Contactors	Reference
3 Pole Contactors	
LC1E06...E25	LAEX12**
LC1E32/E38	LAEX2**
LC1E40/E65	LAEX3**
LC1E80/E95	LAEX4**
LC1E120/E160	LAEX5**
LC1E200/E250	LAEX6**
LC1E300	LAEX7**

* Reference to be completed by adding coil voltage code and recommended to check availability with Customer Care team

** For more information contact regional sales office

For details on non standard references, technical parameters, accessories, compatibility, stockable and non stockable status please contact Customer Care

NORMAL STOCK ITEMS

W.E.F. January 25th, 2022

EasyPact TVS

Power Contactors - ETVS (4 Pole AC Control)



- Conformance to IEC 60947-4-1, CE Marking
- Current Rating: 20A to 125A, AC-1 rating
- Available in 4NO and 2NO+2NC Power Pole combination
- Wide Band Coil for all ratings in 220 & 415V AC

Frame	AC-1 Rating	Power Poles	Reference	Unit MRP [₹]	Power Poles	Reference	Unit MRP [₹]
FRAME-1	20	4NO	LC1E06004*IN	1530	2NO + 2NC	LC1E06008*IN	1830
	25	4NO	LC1E09004*IN	1625	2NO + 2NC	LC1E09008*IN	1970
	32	4NO	LC1E12004*IN	1690	2NO + 2NC	LC1E12008*IN	2110
	40	4NO	LC1E18004*IN	2110	2NO + 2NC	LC1E18008*IN	2125
FRAME-2	50	4NO	LC1E25004*IN	2675	2NO + 2NC	LC1E25008*IN	3795
	55	4NO	LC1E32004*IN	4505	2NO + 2NC	LC1E32008*IN	7150
	60	4NO	LC1E38004*IN	5275	2NO + 2NC	LC1E38008*IN	7460
FRAME-3	75	4NO	LC1E40004*IN	8225	2NO + 2NC	LC1E40008*IN	11050
	85	4NO	LC1E65004*IN	11125	2NO + 2NC	LC1E65008*IN	13815

Frame	AC-1 Rating	Power Poles	Reference	Unit MRP [₹]	Power Poles	Reference	Unit MRP [₹]
FRAME-4	110	4NO	LC1E80004*IN	14090	2NO + 2NC	LC1E80008*IN	19615
	125	4NO	LC1E95004*	15885			

* Reference to be completed by adding coil voltage code and recommended to check availability with Customer Care team

Control Relays - CAE, Conformance to IEC60947-5-1, CE Marking

Auxiliary Contacts		Reference	Unit MRP [₹]
NO	NC		
4	0	CAE40*	1275
3	1	CAE31*	
2	2	CAE22*	

* Reference to be completed by adding coil voltage code and recommended to check availability with Customer Care team

Spare Coil for Contactors

Contactors	Reference
4 Pole Contactors	
LC1E0600*... LC1E1800*	LAEX1T**
LC1E2500*... LC1E3800*	LAEX2T**
LC1E4000*...LC1E9500*	LAEX4T**
Control Contactors	
CAE*	LAEX12**

* Reference to be completed by adding coil voltage code and recommended to check availability with Customer Care team

Coil Voltage Code

* Voltage (V AC)	24	110	220	415
LC1E0600*...9500* 50/60 Hz	B7	F7	-	-
LC1E0600*...9500* 50 Hz/ Wide Band	-	-	M5WB	N5WB
Control relay CAE 50 Hz	B5	F5	M5	N5

Note:

For non standard voltages (Except 110 and 220 V AC) please consult Customer Care for prices

* Reference to be completed by adding coil voltage code and recommended to check availability with Customer Care team

For details on non standard references, technical parameters, accessories, compatibility, stockable and non stockable status please contact Customer Care

NORMAL STOCK ITEMS

W.E.F. January 25th, 2022

Accessories - For ETVS Contactors

Description	For Use with	Mounting	Contacts	Reference	Unit MRP [₹]
Auxiliary contact block	LC1E06..E630 & LC1E0600..E9500	FRONT	1NO+1NC	LAEN11 <input checked="" type="checkbox"/>	380
			2NO	LAEN20 <input checked="" type="checkbox"/>	
			2NC	LAEN02 <input checked="" type="checkbox"/>	450
			2NO+2NC	LAEN22 <input checked="" type="checkbox"/>	695
			4NO	LAEN40 <input checked="" type="checkbox"/>	
Star delta timer	LC1E25..E630			LAETSD <input checked="" type="checkbox"/>	3150

For 415v control supply please contact customer care team

Description	For Use with	Coil Voltage	Reference	Unit MRP [₹]
Surge suppressor*	LC1E06...E95	24..48V AC	LAERCE	1460
	LC1E06...E95	110..240V AC	LAERCU	885

*For higher rating contactors, contact nearest sales office

Description	For Use with	Reference	Unit MRP [₹]
Mechanical Interlock	LC1E06..E65 & LC1E0600*..E3800*	LAEM1	790
	LC1E80/E95 & LC1E4000*...LC1E9500*	LAEM4	2570
	LC1E120..E160	LAEM5	4795
	LC1E200/E250	LAEM6	4885

*Reference to be completed by adding coil voltage

3 Pole Accessories Compatibility

Contactor	Built in contacts	LAEN**	LAERC*	LAEM
LC1E06	1NO or 1NC	1	1	1
LC1E09				
LC1E12				
LC1E18				
LC1E25				
LC1E32				
LC1E38				
LC1E40B	1NO + 1NC	1	1	1
LC1E40				
LC1E50				
LC1E65				
LC1E80				
LC1E95				
LC1E120				
LC1E160				
LC1E200				
LC1E250				
LC1E300				
LC1E400				
LC1E500				
LC1E630				

4 Pole Accessories Compatibility

Contactor	LAEN**	LAEM	LAERC*
LC1E06	1	1	1
LC1E09			
LC1E12			
LC1E18			
LC1E25			
LC1E32			
LC1E38			
LC1E40			
LC1E50			
LC1E65			
LC1E80			
LC1E95			

Control Relay Accessories Compatibility

Control Relay	LAEN*	LAERC
CAE	1 of LAEN11 or LAEN20 or LAEN02 or LAEN22	1

For details on non standard references, technical parameters, accessories, compatibility, stockable and non stockable status please contact Customer Care

NORMAL STOCK ITEMS

W.E.F. January 25th, 2022

EasyPact TVS

Thermal Overload Relay - ETVS



- Conformance to IEC 60947-4-1, CE Marking
- Range : 0.1A to 630A
- Tripping Class : 10A
- Direct & Independent mounting

Thermal Protection Adjustment Range	For Use with Contactor	Reference	Unit MRP [₹]
LRE			
0.25...0.4	E06...E38	LRE03	2025
0.4...0.63	E06...E38	LRE04	
0.63...1	E06...E38	LRE05 ✓	
1...1.6	E06...E38	LRE06 ✓	
1.6...2.5	E06...E38	LRE07 ✓	
2.5...4	E06...E38	LRE08 ✓	
4...6	E06...E38	LRE10 ✓	
5.5...8	E09...E38	LRE12 ✓	
7...10	E09...E38	LRE14 ✓	
9...13	E12...E38	LRE16 ✓	
12...18	E18...E38	LRE21 ✓	2240
16...24	E25...E38	LRE22 ✓	2590
23...32	E25...E38	LRE32 ✓	3465
30...38	E38	LRE35 ✓	3900
17...25	E40...E95	LRE322	4405
23...32	E40...E95	LRE353	
30...40	E40...E95	LRE355	
37...50	E50...E95	LRE357 ✓	
48...65	E65...E95	LRE359	5775

Thermal Protection Adjustment Range	For Use with Contactor	Reference	Unit MRP [₹]
LRE			
55...70	E80...E95	LRE361	6845
63...80	E80...E95	LRE363	7145
80...104	E95	LRE365	
51...81	E120...E300	LRE480	13380
62...99	E120...E300	LRE481	
84...135	E120...E300	LRE482	
124...198	E160...E300	LRE483	
146...234	E200...E300	LRE484	
174...279	E250...E300	LRE485	14580
208...333	E300	LRE486	
258...414	E300...E400	LRE487	

Accessories for Relay

Accessory	For Relay	Reference	Unit MRP [₹]
Separate Mounting Block	LRE01...LRE35	LAEB1	715
	LRE322...LRE365	LAEB3	1645

For details on non standard references, technical parameters, accessories, compatibility, stockable and non stockable status please contact Customer Care

✓ NORMAL STOCK ITEMS

W.E.F. January 25th, 2022

EasyPact TVS

Circuit Breaker for Motor Protection - GZ1E - Pushbutton control



- Conformance to IEC60947-1,-2,-4, CE Marking
- Range : 0.1A to 32A
- Breaking Capacity upto 100KA

Motor Protection Circuit Breaker - ETVS

Breaking Capacity at 415 V 50 Hz	Motor Power AC3**		Thermal Protection Adjustment Range (A)	Reference	Unit MRP [₹]
	kW	hP			
GZ1-E Thermal Magnetic - With Pushbutton Control					
100 kA	-	-	0.1 - 0.16	GZ1E01	3660
	0.06	-	0.16 - 0.25	GZ1E02	
	0.09	-	0.25 - 0.40	GZ1E03	
	0.18	-	0.40 - 0.63	GZ1E04	
	0.37	0.5	0.63 - 1.0	GZ1E05	
	0.55	0.75	1.0 - 1.6	GZ1E06	
	0.75	1	1.6 - 2.5	GZ1E07	
	1.1	2	2.5 - 4	GZ1E08	
	2.2	3	4 - 6.3	GZ1E10	
	3	5.5	6 - 10	GZ1E14	
10 kA*	5.5	7.5	9 - 14	GZ1E16	4620
	7.5	10	13 - 18	GZ1E20	5210
	9	12.5	17 - 23	GZ1E21	5665
	11	15	20 - 25	GZ1E22	5970
	15	20	24 - 32	GZ1E32	6270
					11190

Breaking Capacity at 415 V 50 Hz	Motor Power AC3**		Magnetic Protection (A)	Reference	Unit MRP [₹]
	kW	hP			
GZ1-LE Magnetic- With Pushbutton Control					
100 kA	0.09	-	0.4	GZ1LE03	2675
	0.18	-	0.63	GZ1LE04	
	0.37	0.5	1	GZ1LE05	
	0.55	0.75	1.6	GZ1LE06	
	0.75	1	2.5	GZ1LE07	
	1.1	2	4	GZ1LE08	
	2.2	3	6.3	GZ1LE10	
	3	5.5	10	GZ1LE14	
	5.5	7.5	14	GZ1LE16	
	7.5	10	18	GZ1LE20	
10 kA*	11	15	25	GZ1LE22	2890
	15	20	32	GZ1LE32	3425

* 50kA With current Limiter type GV1L3

Accessories - ETVS Circuit Breaker for Motor Protection

Description	Mounting	Contacts	Reference	Unit MRP [₹]
Auxillary Contact Block	LH side Mounted	1NO+1NC	GZ1AN11	680
		2NO	GZ1AN20	815

Description	Mounting	Range	Reference	Unit MRP [₹]
Electric Trips				
Undervoltage	RH Side Mounted	110...115V	50Hz	GZ1AU115
		220...240V	50Hz	GZ1AU225
		380...400V	50Hz	GZ1AU385
Shunt trip		110...115V	50Hz	GZ1AS115
		220...240V	50Hz	GZ1AS225

For details on non standard references, technical parameters, accessories, compatibility, stockable and non stockable status please contact Customer Care

NORMAL STOCK ITEMS

W.E.F. January 25th, 2022



Green Premium™

An industry leading portfolio of offers delivering sustainable value



More than 75% of our product sales offer superior transparency on the material content, regulatory information and environmental impact of our products:

- RoHS compliance
- REACh substance information
- Industry leading # of PEP's*
- Circularity instructions



Discover what we mean by green
Check your products!

The Green Premium program stands for our commitment to deliver customer valued sustainable performance. It has been upgraded with recognized environmental claims and extended to cover all offers including Products, Services and Solutions.

CO2 and P&L impact through... Resource Performance

Green Premium brings improved resource efficiency throughout an asset's lifecycle. This includes efficient use of energy and natural resources, along with the minimization of CO₂ emissions.

Cost of ownership optimization through... Circular Performance

We're helping our customers optimize the total cost of ownership of their assets. To do this, we provide IoT-enabled solutions, as well as upgrade, repair, retrofit, and remanufacture services.

Peace of mind through... Well-being Performance

Green Premium products are RoHS and REACh compliant. We're going beyond regulatory compliance with step-by-step substitution of certain materials and substances from our products.

Improved sales through... Differentiation

Green Premium delivers strong value propositions through third-party labels and services. By collaborating with third-party organizations we can support our customers in meeting their sustainability goals such as green building certifications.



TeSys

> Control > Protect > Power > Active

Innovative and connected solutions for motor starters

TeSys is an innovative motor control and management solution from the global market leader. TeSys offers connected, efficient products and solutions for switching and protection of motors and electrical loads in compliance with all major global electrical standards

NEW

TeSys Function Names

TeSys components are grouped by function name, for easier identification. These functions are related to motor, power, control and protection.

> TeSys Power:

Components for powering motors



> TeSys Control:

Components for controlling motors



> TeSys Protect:

Components for protecting motors



> TeSys Active:

Connected components for motor circuits

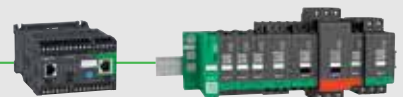



Start smart. Run smart. With TeSys motor controls.

Stay smart with the world's best-selling motor control solutions from the inventor of the world's first contactor - Schneider Electric™.

For almost a century, TeSys motor controls have driven the industry with innovations in motor protection, monitoring, and control.

It started with the introduction of the industry's first BAR contactor in 1924, and today, the legacy of innovation is built into every TeSys motor control device. Best-in-class safety and reliability, plug-and-play architecture, and flexible functionality mean TeSys motor control solutions can meet your requirements across a wide range of applications, from the most common to the most advanced.

Wherever you are and anywhere your projects come together, you can trust Schneider Electric and TeSys contactors, circuit breakers, relays, and switches for unmatched reliability, complete compatibility with international standards, and the robust support of the Schneider Electric global supply network. Start smart, run smart and stay smart with TeSys motor controls.

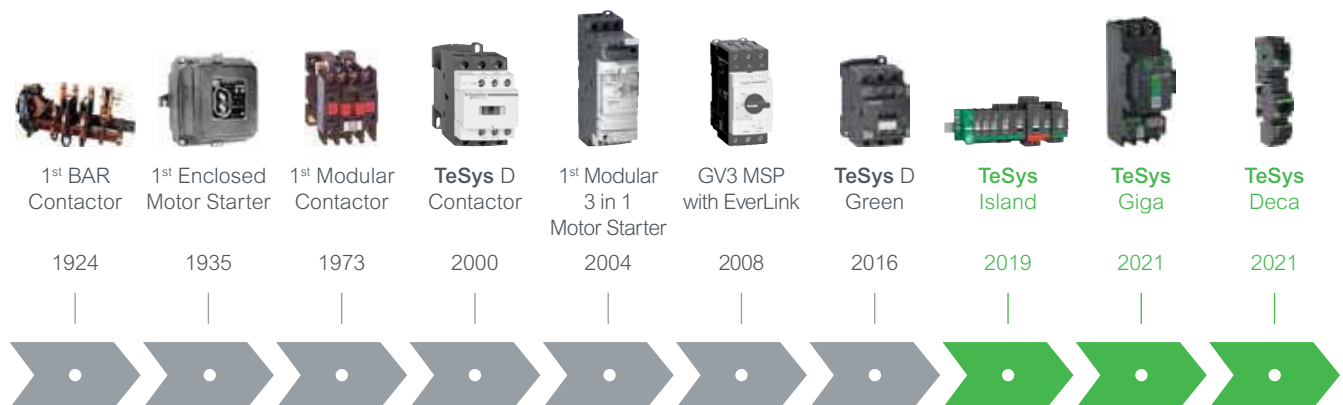

How do everlinks improve power connection reliability?

For more information on switching and motor management scan!



Superior safety for all industries

TeSys motor controls come with all of the isolation, protection and emergency handling you need to comply with international codes. High-contrast covers identify safety-critical devices to prevent inadvertent manual operation. Every **TeSys** contactor is both mechanically linked and equipped with mirror contacts for safety applications and wherever auxiliary contact state reliability is critical.



HVAC

Ensure 24/7 availability of your HVAC system with reliable products that can reach high ambient temperatures without derating.



Conveying

Decentralize the control cabinet of your conveyor line and benefit from up to 80% space reduction.



Genset

Make certain your generator starts even in the harshest conditions with our robust solutions.



Pumping

Optimize single or multi-drive boosters for industry or infrastructure with energy and cost-effective solutions.



Packaging

Keep pace with the most demanding, high-end packing applications with our solutions



Oil and Gas

Keep your employees and assets safe and improve uptime in onshore and offshore applications: pipeline operations: LNG and natural gas processing: and refining and petrochemical applications.



Water and Wastewater

Optimize the treatment and delivery of safer water by reducing energy usage and lowering operating costs.



Food and Beverage

Serve your customers with environmentally friendly products to improve sustainability, efficiency, and flexibility, allowing you to adapt to changing customer habits.

Online selection tool

EcoStruxure™ Motor Control Configurator

For Direct-On-Line and Star-Delta starters, motor circuit breakers with advanced protection, motor management relays, configurations for total coordination, drives, and soft starters.

No matter what kind of starting method you need, our online **EcoStruxure™ Motor Control Starter Configurator** will help you to quickly and easily select the optimal combination of components to ensure maximized motor safety, protection, and uptime.



Scan or click on the QR code

TeSys Range

NEW

TeSys Component Series Names

Series names are now grouped as per the current ratings

- Series names group conventional components (circuit breakers, contactors, relays, overcurrent relays) by current rating ranges.
 - 0 to 16 A > **TeSys K** Series
 - 9 to 150 A > **TeSys 'Deca'** Series
 - 185 to 800 A > **TeSys 'Giga'** Series.
- TeSys advanced components have a specific classification.
 - 0 to 38 A All-in-one starters > **TeSys 'Ultra'** Series
 - 0 to 80 A Motor Control/Protection/Monitoring system > **TeSys 'island'** Series.
- Other TeSys component names remain unchanged (TeSys F, TeSys B, TeSys T).

> TeSys K Series

The essential line for motors up to 7.5kW/16A direct on TeSys K series of Motor Starters



> TeSys Deca Series

The industrial standard for motors up to 75kW/150A direct on TeSys Deca series of Motor Starters



> TeSys Giga Series

For large motors up to 450kW/800A direct on TeSys Giga Series



> TeSys Ultra Series

The most compact totally coordinated solution for Motor Starters. For Direct On Line or Reversing Motor Control and Drive Protection upto 18.5kW/38 A on TeSys Ultra series



> TeSys Island Series

Digitally powered monitoring, control and protection of electrical motors up to 37kW/80 A on TeSys Island Series



TeSys Control

TeSys K

Control Relays - K Model (AC & DC Control)



- Conformance IEC, UL, CSA, CE Marking
- Inbuilt 4 auxiliary contacts
- 10A thermal rating
- Available with AC (50/60Hz Dual frequency), DC & DC low consumption coil options

No of Poles	AC Control Reference	Unit MRP [₹]	DC Control Reference ⁽⁴⁾	Unit MRP [₹]	DC low consumption Reference ^{(1) (2) (3)}	Unit MRP [₹]
2NO + 2NC	CA2KN22*	1595	CA3KN22**	2200	CA4KN22***	2730
3NO + 1NC	CA2KN31*		CA3KN31**		CA4KN31***	
4NO	CA2KN40*	CA4KN40***				

- (1) Compatible with PLC outputs
 (2) Wide range coil (0.7...1.25Uc), suppressor fitted as standard
 (3) 2 pole auxiliary contact block can be mounted additionally
 (4) Optional in-built surge suppressor available

Power Contactors - K Model (3 Pole AC & DC Control)



- Conformance to IEC, UL, CSA
- Current Rating : 6A to 16A, AC-3 duty
- 1NO or 1NC inbuilt auxiliary contact
- Available in 3P & 4P version
- Available with AC (50/60Hz Dual frequency), DC & DC low consumption⁽⁵⁾ coil options

[Ie] Rated Operational Current (A)	Motor Power (kW)	Auxiliary Contacts	AC Control Reference	Unit MRP [₹]	DC Control Reference ⁽⁵⁾	Unit MRP [₹]
6	3	1NC	LC1K0601*	1355	LP1K0601**	2095
		1NO	LC1K0610*		LP1K0610**	
9	5.5	1NC	LC1K0901*	1415	LP1K0901**	2280
		1NO	LC1K0910*		LP1K0910**	
12	7.5	1NC	LC1K1201*	1600	LP1K1201**	2645
		1NO	LC1K1210*		LP1K1210**	
16	10	1NC	LC1K1601*	1890	-	-
		1NO	LC1K1610*		-	-

(5) For low consumption offer, please contact regional sales office

Reversing Contactors - K Model



- Conformance to IEC, UL, CSA, CE
- Current Rating : 6A to 16A, AC-3 duty
- 1NO or 1NC inbuilt auxiliary contact
- Available in 3P & 4P version
- Available with AC(50/60Hz Dual frequency), DC & DC low consumption⁽⁶⁾ coil options

[Ie] Rated Operational Current (A)	Motor Power (kW)	Auxiliary Contacts	AC Control Reference	Unit MRP [₹]
6	3	1NC	LC2K0601*	4505
		1NO	LC2K0610*	
9	5.5	1NC	LC2K0901*	4810
		1NO	LC2K0910*	
12	7.5	1NC	LC2K1201*	4955
		1NO	LC2K1210*	
16	10	1NC	LC2K1601*	6665
		1NO	LC2K1610*	

* Reference to be completed by adding coil voltage code
 (6) For current rating and ref please contact Customer Care

Coil Voltage Code

Type	Voltage	24	48	72	110	220	415
AC*	CA2KN, LC1-K06 to K16, 50/60Hz	B7	-	-	F7	M7	N7
	LC2-K06 to K16, 50/60Hz	-	-	-	F7	M7	N7
DC**	CA3KN, LP1-K06 to K12	BD	-	-	FD	MD	-
DC low consumption***	CA4KN	BW3	EW3	SW3	-	-	-

Note: (1) For Non standard coil voltage (Except 110, 240 V AC and 24 V DC) prices please contact customer care.
 (2) Reference to be completed by adding coil voltage code and recommended to check availability with Customer Care team rating.

For details on non standard references, technical parameters, accessories, compatibility, stockable and non stockable status please contact Customer Care

NORMAL STOCK ITEMS

W.E.F. January 25th, 2022

TeSys Control

TeSys K

Accessories - K Model

Description	Mounting	Contacts	Reference	Unit MRP [₹]
Auxiliary contact block	Front	2NC	LA1KN02	660
		1NO + 1NC	LA1KN11 <input checked="" type="checkbox"/>	605
		2NO	LA1KN20	660
		4NC	LA1KN04	1025
		1NO + 3NC	LA1KN13	
		2NO + 2NC	LA1KN22 <input checked="" type="checkbox"/>	
		3NO + 1NC	LA1KN31	
		4NO	LA1KN40	

Description	Control Voltage	Range	Reference	Unit MRP [₹]
On Delay Electronic Timer	24..48V AC/DC	1..30S	LA2KT2E ⁽¹⁾	3350
	110..240V AC	1..30S	LA2KT2UA ⁽¹⁾	

Description	Coil Voltage	Reference	Unit MRP [₹]
Surge Suppressor - RC Circuit	220..250V AC	LA4KA1U*	1045
Surge Suppressor - Varistor	130..250V AC/DC	LA4KE1UG*	
Surge Suppressor - Varistor	50..129V AC/DC	LA4KE1FC*	

* Lot size 5

(1) Front mounted with common point changeover contact

For details on non standard references, technical parameters, accessories, compatibility, stockable and non stockable status please contact Customer Care

NORMAL STOCK ITEMS

W.E.F. January 25th, 2022

TeSys Control

TeSys Deca NEW

The next-generation TeSys Deca series motor starters offer a reliable and robust solution for a faster machine time-to-market. It has a new modern look & feel and is designed to meet the requirements of Electro domestic applications. Ease of operation and reliability is guaranteed with the new multi-standard screws. Digital customer experience is enhanced with a QR embedded from product to packaging.

TeSys Deca Control Contactors (AC & DC Control)



- Conformance to IEC, UL, CSA
- 5 inbuilt auxiliary contacts, in just 2 variants
- Available with AC (50/60Hz Dual frequency), DC & DC low consumption coil options
- High Operating ambient temperature upto 60 Deg C
- Inbuilt surge suppressor for DC & DC low consumption

No of Poles	AC Control Reference	Unit MRP [₹]	DC Control Reference ⁽²⁾	Unit MRP [₹]	DC low consumption Reference ^{(1) (2) (3)}	Unit MRP [₹]
3NO + 2NC	CAD32*	1700	CAD32**	2430	CAD32***	3040
5NO	CAD50*		CAD50**		CAD50***	

(1) Compatible with PLC outputs

(2) Wide range coil (0.7...1.25Uc), suppressor fitted as standard

(3) 2 pole auxiliary block can be mounted

TeSys Deca Power Contactors (3P AC & DC)



- Conformance to IEC, UL, CSA
- Current Rating : 9A to 150A
- Available with AC (50/60Hz Dual frequency), DC & DC low consumption coil options
- High Operating ambient temperature, no derating upto 60 Deg C
- Inbuilt 1NO + 1NC auxiliary contacts upto 150A
- High electrical and mechanical life
- Fuse-less Type 2 Co-ordination Charts available
- EverLink® terminal for 40, 50, 65 & 80A contactors
- Inbuilt surge suppressor in DC coil for 9-80A

[le] Rated Operational Current AC-1	AC-3 Duty			Auxiliary Contacts	AC Control Reference	Unit MRP [₹]	DC Control Reference ⁽¹⁾	Unit MRP [₹]
	kW	HP	A					
25	4	5.5	9	1NO + 1NC	LC1D09* <input checked="" type="checkbox"/>	1730	LC1D09** <input checked="" type="checkbox"/>	2715
	5.5	7.5	12	1NO + 1NC	LC1D12* <input checked="" type="checkbox"/>	1945	LC1D12** <input checked="" type="checkbox"/>	3055
32	9	12.5	18	1NO + 1NC	LC1D18* <input checked="" type="checkbox"/>	2255	LC1D18** <input checked="" type="checkbox"/>	3765
40	11	15	25	1NO + 1NC	LC1D25* <input checked="" type="checkbox"/>	2790	LC1D25** <input checked="" type="checkbox"/>	4760
50	15	20	32	1NO + 1NC	LC1D32* <input checked="" type="checkbox"/>	5430	LC1D32** <input checked="" type="checkbox"/>	9700
	18.5	25	38	1NO + 1NC	LC1D38* <input checked="" type="checkbox"/>	7830	LC1D38** <input checked="" type="checkbox"/>	11465
60	22	30	40	1NO + 1NC	LC1D40A* <input checked="" type="checkbox"/>	8215	LC1D40A#	13735
80	25	35	50	1NO + 1NC	LC1D50A* <input checked="" type="checkbox"/>	10605	LC1D50A#	17230
80	37	50	65	1NO + 1NC	LC1D65A* <input checked="" type="checkbox"/>	14710	LC1D65A#	19540
80	37	50	80	1NO + 1NC	LC1D80A* <input checked="" type="checkbox"/>	18385	LC1D80A#	23720
	45	60	80	1NO + 1NC	LC1D80* <input checked="" type="checkbox"/>	22680	LC1D80**	26540
125	45	60	95	1NO + 1NC	LC1D95* <input checked="" type="checkbox"/>	23905	LC1D95**	29085
	59	80	115	1NO + 1NC	LC1D115* <input checked="" type="checkbox"/>	29420	LC1D115**	34375
250	80	110	150	1NO + 1NC	LC1D150* <input checked="" type="checkbox"/>	36775	LC1D150**	41250

* Reference to be completed by adding coil voltage code and recommended to check availability with Customer Care team

For details on non standard references, technical parameters, accessories, compatibility, stockable and non stockable status please contact Customer Care

NORMAL STOCK ITEMS

W.E.F. January 25th, 2022

TeSys Deca Power Contactors (3 Pole DC Low Consumption)

Now available upto 80A with the TeSys Deca Green Low Consumption offer

[Ie] Rated Operational Current AC-1	kW	Motor Power AC-3 HP	A	Auxiliary Contacts	Reference	Unit MRP [₹]
25	4	5.5	9	1NO + 1NC	LC1D09**** <input checked="" type="checkbox"/>	2980
	5.5	7.5	12	1NO + 1NC	LC1D12**** <input checked="" type="checkbox"/>	3335
32	9	12.5	18	1NO + 1NC	LC1D18**** <input checked="" type="checkbox"/>	5100
40	11	15	25	1NO + 1NC	LC1D25**** <input checked="" type="checkbox"/>	6215
50	15	20	32	1NO + 1NC	LC1D32**** <input checked="" type="checkbox"/>	10625

[Ie] Rated Operational Current AC-1	kW	Motor Power AC-3 HP	A	Auxiliary Contacts	Reference	Unit MRP [₹]
60	22	30	40	1NO + 1NC	LC1D40A#	13735
80	25	35	50	1NO + 1NC	LC1D50A#	17230
80	37	50	65	1NO + 1NC	LC1D65A#	19540
80	37	50	80	1NO + 1NC	LC1D80A#	23720

* Reference to be completed by adding coil voltage code and recommended to check availability with Customer Care team

TeSys Deca Power Contactors (4 Pole AC & DC Control)



- Conformance to IEC, UL, CSA
- Current Rating : 20A to 250A, AC-1 Rating
- Available with AC (50/60Hz Dual frequency), DC & DC low consumption (1) coil options
- High Operating ambient temperature, no derating upto 60 deg C

[Ie] Rated Operational Current AC-1	Poles Composition	AC Control Reference	Unit MRP [₹]	DC Control Reference	Unit MRP [₹]
20	4NO	-	-	LC1DT20**	3240
	2NO + 2NC	-	-	LC1D098**	3525
25	4NO	-	-	LC1DT25**	3885
	2NO + 2NC	-	-	LC1D128**	5075
32	4NO	-	-	LC1DT32**	4270
	2NO + 2NC	-	-	LC1D188**	5780
40	4NO	-	-	LC1DT40**	6700
	2NO + 2NC	-	-	LC1D258**	8830
60	4NO	-	-	LC1DT60A#	13410
	2NO + 2NC	-	-	LP1D40008**	17620

[Ie] Rated Operational Current AC-1	Poles Composition	AC Control Reference	Unit MRP [₹]	DC Control Reference	Unit MRP [₹]
80	4NO	-	-	LC1DT80A#	20000
	2NO + 2NC	-	-	LP1D65008**	23685
125	4NO	-	-	LP1D80004**	25655
	2NO + 2NC	-	-	LP1D80008**	29605
250	4NO	LC1D1150046*	32340	LC1D1150046**	35925

* Reference to be completed by adding coil voltage code and recommended to check availability with Customer Care team

Coil Voltage Code

Type	Voltage	24	48	72	110	220	415
AC*	CAD, LC1D09-D150 50/60 Hz	B7	-	-	F7	M7	N7
	LC1D1150046 50/60 Hz	-	-	-	F7	M7	N7
DC**	CAD, LC1D09-D38, LC1D80-D150	BD	-	-	FD	MD	-
	LC1DT20-DT40, LC1D098-D258, LP1D40-D80, LC1D115	BD	-	-	FD	MD	-
DC Low Consumption***	CAD	BL	-	-	FL	ML	-
	LC1D09-D32	BL	EL	SL	-	-	-

Type	Voltage	24V DC Low consumption	24-60V AC/DC	48-130V AC/DC	100-250V AC/DC
TeSys Deca Green#	LC1D40A-80A, LC1DT60A-DT80A	BBE	BNE	EHE	KUE

Note: Please contact Customer Care for 4 Pole AC coil contactor details
For Non standard coil voltage prices please contact customer care

(1) For current rating and ref please contact Customer Care

(2) Reference to be completed by adding coil voltage code and recommended to check availability with Customer Care team

For details on non standard references, technical parameters, accessories, compatibility, stockable and non stockable status please contact Customer Care

NORMAL STOCK ITEMS

W.E.F. January 25th, 2022



TeSys Deca Green

The Revolutionary Electronic Coil Contactor



80A AC3 offer
in 55mm frame



Complete range in 3 frame sizes:

09-12-18A

25-32-38A

40-50-65-80A

 -80%

Up to 80% less energy consumption than a traditional electromechanical motor starter

10X Reduction
in references

Only 3 references to cover the complete voltage range for AC and DC

 -35%

Highest currents in smallest size, e.g. 80A in 55mm instead of 84mm

PLC Compatible

Direct connection to a PLC without the need for an interposing relay

SEMIF47

High uptime thanks to wide band coil with high resistance to voltage surges/SEMIF47 conform



Scan to see TeSys Deca Green under voltage performance.

TeSys Deca Green Contactor (3 Pole AC/DC Universal Coil)



- Current Rating: 9-65A
- Universal AC/DC coil from 24 - 250V
- Special low consumption offer from 40-80A
- Fuseless Type 2 Co-ordination charts available

The Revolutionary Electronic Coil Contactor

[Ie] Rated Operational Current AC-1	AC-3 Duty (Long Life)			Auxiliary Contacts	Reference	Unit MRP [₹]
	kW	HP	A			
25	4	5.5	9	1NO + 1NC	LC1D09*	3540
	5.5	7.5	12	1NO + 1NC	LC1D12*	3670
32	9	12.5	18	1NO + 1NC	LC1D18*	4845
40	11	15	25	1NO + 1NC	LC1D25*	5780
50	15	20	32	1NO + 1NC	LC1D32*	11750
	18.5	25	38	1NO + 1NC	LC1D38*	12680
60	22	30	40	1NO + 1NC	LC1D40A*	13735
80	25	35	50	1NO + 1NC	LC1D50A*	17230
80	37	50	65	1NO + 1NC	LC1D65A*	19540
80	37	50	80	1NO + 1NC	LC1D80A*	23720

TeSys Deca Green Power Contactors (4 Pole AC & DC Control)

[Ie] Rated Operational Current AC-1	Poles Composition	Auxiliary Contacts	DC Control Reference	Unit MRP [₹]
60	4NO	1NO + 1NC	LC1DT60A*	13410
80	4NO	1NO + 1NC	LC1DT80A*	20000

Coil Voltage Code

Type	Voltage	24-60V AC/DC	48-130V AC/DC	100-250V AC/DC
AC/DC*	LC1D09 - D38, LC1D40A - 80A, LC1DT60A - 80A	BNE	EHE	KUE
24V DC Low Consumption*	LC1D40A - 80A, LC1DT60A - 80A	BBE (24V DC only)	-	-

* Reference to be completed by adding coil voltage code and recommended to check availability with Customer Care team



Check the features of
the TeSys Deca Green

Description	For use with	Reference	Unit MRP [₹]
Power connection accessories			
Terminal block	For supply to one or more GV2 G busbar sets	GV1G09	2130
Set of 63A busbars for parallelling of contactors	2 contactors LC1D09...D18 or D25...D38	GV2G245	1865
	4 contactors LC1D09...D18 or D25...D38	GV2G445	2935
Set of 115A busbars for parallelling of contactors	2 contactors LC1D40A...D80A	GV3G264	3350
	3 contactors LC1D40A...D80A	GV3G364 ⁽¹⁾	1790
Set of S-shape busbars	For circuit breakers GV3P** & GV3L** and contactors LC1 D40A...D65A	GV3S	1340

**Not applicable for GV3P/GV3L 73A and 80A



GV2G245



GV1G09

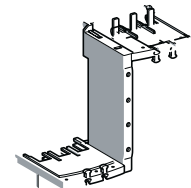

GV3S

Description	For use with	Reference	Unit MRP [₹]
Mechanical interlock	LC1D09 to D38(1)	LAD9V2	745
	LC1D40A to D65A(1)	LAD4CM	1515
	LC1D80 and D95 (for AC control voltage)	LA9D4002	3315
	LC1D80 and D95 (for DC control voltage)(2)	LA9D8002	4935
	LC1D115 and D150(2)	LA9D11502	5005

(1) With this set of busbars, any one contactor can be supplied directly by its EverLink® double cage power terminal block. The other two contactors are supplied by the busbar set. The 115A limitation is therefore applied to these two contactors.
 (2) With electrical interlock

Description	For use with	Reference	Unit MRP [₹]
Power Connection for Reversing			
Kit Comprising :			
1. A set of parallel bars	LC1D09 to D38	LAD9V5 + LAD9V6	1385
2. A set of reverser bars.	LC1D40A to D80A	LA9D65A69	3220
	LC1D80 and D95 (for AC control voltage)	LA9D8069	6890
	LC1D80 and D95 (for DC control voltage)	LA9D8069	6890
	LC1D115 and D150	LA9D11569	11460

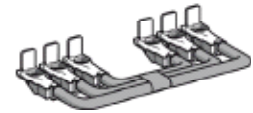
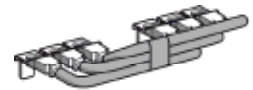

LA9 D8069

Description	For use with	Reference	Unit MRP [₹]
Reversing Kit			
Kit Comprising :			
1. A mechanical interlock LAD 9V2 with electrical interlocking LAD 9V1	LC1D09 to D38	LAD9R1V	1545
2. A set of power connections LAD 9V5 (parallel) and LAD 9V6 (reversing).			
Kit Comprising :			
1. A mechanical interlock LAD 9V2 without electrical interlocking	LC1D09 to D38	LAD9R1	1410
2. A set of power connections LAD 9V5 (parallel) and LAD 9V6 (reversing).			
Kit Comprising :			
1. A mechanical interlock LAD 4CM	LC1D40A to D80A	LAD9R3	3675
2. A set of power connections LA9 D65A69.			

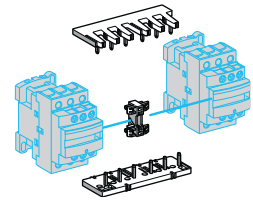

LAD9R1

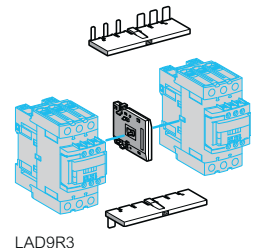

LAD9R3

Description	For use with	Reference	Unit MRP [₹]
Star Delta Kit			
Time delay contact block LAD S2 (LC1D09...D80),	LC1D09 and D12	LAD91217	5810
Power circuit connections (LC1D09...D80),	LC1D18 to D32	LAD93217	7470
Hardware required for fixing the contactors onto the mounting plate (LC1D80)	LC1D40A and D50A	LAD9SD3	15100
	LC1D80	LA9D8017	16765



LAD91217



LAD9SD3



LA9D8017

For details on non standard references, technical parameters, accessories, compatibility, stockable and non stockable status please contact Customer Care

NORMAL STOCK ITEMS

W.E.F. January 25th, 2022

Description	Time Delay Range	Timer Type	Reference	Unit MRP [₹]
On delay timer ^{(1) (2)}	15...30 s	on delay	LA4DT2U	5140
On delay timer ^{(1) (2)}	0.1...2 s	on delay	LA4DT0U	
On delay timer ^{(1) (2)}	25...500 s	on delay	LA4DT4U	5760
Relay interface module - 24V DC ^{(1) (2)}	-	-	LA4DFB	4735

(1) For LC1 D09...38A (3P, AC coils only) add mounting adaptor LAD4BB and for LC1 D40A...65A (3P, AC coils only), add mounting adaptor LAD4BB3.

(2) For LC1D80...150 (3P), direct mounting, for 100-250V AC Coils only.

Description	For use with	Reference	Unit MRP [₹]
TeSys Deca Model Mechanical Latch Blocks			
Front, Clip-on	LC1D09...D38 (a or c) LC1DT20...DT40 (a or c) LC1D40A...D65A (3P a or c) LC1DT60A and DT80A (4P a or c)	LAD6K10*	6180
	LC1D80...D150 (3P a) LC1D80 and D115 (3 P c) LC1D80 (4 P a) LC1D80 and D115 (4 P a) LP1D80 and LC1D115 (4 P c)	LA6DK20*	6450

* Reference to be completed by adding coil voltage code and recommended to check availability with Customer Care team

Coil Voltage Code

VOLTAGE (AC/DC)	24	42/48	110/127	220/240	380/415
Code	B	E	F	M	Q

Spare Coils TeSys Deca Model

Product Compatibility	Reference
AC Coils	
CAD, LC1-D09...D38, DT20..40	LXD1*
LC1D40A, D50A, D65A & LC1DT60A, DT80A	LXD3*
D80 & D95 (3P & 4P)	LX1D6*
LC1-D115, D150	LX1D8*
DC Coils	
LC1-D80-D95	LX4D7**
LC1-D115, D150	LX4D8**

* Reference to be completed by adding coil voltage code and recommended to check availability with Customer Care team

Coil Voltage Code

Type	Voltage (V)	24	110	220	415
AC*	CAD, LC1-D09...D38, DT20..40, LC1 - D150, LC1D40A, D50A, D65A & LC1DT60A, DT80A, LC1D150 LC1D80, D95, D115	B7	F7	M7	N7

For details on non standard references, technical parameters, accessories, compatibility, stockable and non stockable status please contact Customer Care

NORMAL STOCK ITEMS

W.E.F. January 25th, 2022

Accessories

Description	For use With	Contacts	Reference	Unit MRP [₹]	
Add On Blocks					
Additional instantaneous auxiliary contact blocks	LC1D09 ...LC1D150 & LC1F*	Front Mounted	1NO + 1NC	LADN11	500
			2NO	LADN20 <input checked="" type="checkbox"/>	
			2NC	LADN02	725
			2NO + 2NC	LADN22 <input checked="" type="checkbox"/>	900
			4NC	LADN04	1205
			4NO	LADN40 <input checked="" type="checkbox"/>	900
	1NO + 3NC	LADN13			
	LC1D80..LC1D95 & LC1F	Front Mounted	1NO	LADN10	405
			1NC	LADN01	

Description		Contacts	Reference	Unit MRP [₹]
Add On Blocks				
Additional instantaneous auxiliary contact blocks	Side Mounted ⁽¹⁾	1NO + 1NC	LAD8N11	1740
		2NO	LAD8N20	
Pneumatic timer blocks front mounted	ON delay	1NO + 1NC 0.1..3s	LADT0	3595
		1NO + 1NC 0.1..30s	LADT2	
		1NO + 1NC 10..180s	LADT4	
	OFF delay	1NO + 1NC 1..30s (2)	LADS2 <input checked="" type="checkbox"/>	3835
		1NO + 1NC 0.1 ..3s	LADR0	3595
		1NO + 1NC 0.1 ..30s	LADR2 <input checked="" type="checkbox"/>	
		1NO + 1NC 10..180s	LADR4	

(1) Suitable for mounting on TeSys Deca range AC Coil Contactors and Control Relays only

(2) With Switching time of 40 ms between opening of the NC contact and closing of the NO contact recommended for Star - Delta Starters

Accessories compatibility

Contactors		Instantaneous Auxiliary Contacts					Time delay Front Mounted	
Type	Number of Poles and Size	Side mounted	Front mounted					
			1 contact	2 contact	4 contacts			
AC & AC/DC	3P	LC1D09...D38	1 on LH side	and	-	1	or 1	or 1
		LC1D40A...D80A	1 on LH or 1 on RH side	and	-	1	or 1	or 1
		LC1D80 and D95A (50/60 Hz)	1 on each side	or	2	and 1	or 1	or 1
		LC1D80 and D95A (50 or 60 Hz)	1 on each side	and	2	and 2	or 1	or 1
		LC1D115 and D150	1 on LH side	and	-	1	or 1	or 1
	4P	LC1DT20...DT40	1 on LH side	and	-	1	or 1	or 1
		LC1DT60A and DT80A	1 on LH or 1 on RH side	and	-	1	or 1	or 1
		LC1D40008, D65008 and D80	1 on each side	or	1	or 1	or 1	or 1
		LC1D115	1 on each side	and	1	or 1	or 1	or 1
DC	3P	LC1D09...D38	-	-	1	or 1	or 1	
		LC1D40A...D80A	-	-	1	or 1	or 1	
		LC1D80 and D95	-	-	1	or 1	or 1	
	4P	LC1D115 and D150	1 on LH side	and	-	1	or 1	or 1
		LC1DT20...DT40	-	-	1	or 1	or 1	
		LC1DT60A and DT80A	-	-	1	or 1	or 1	
		LC1D40008, D65008 and D80	-	-	2	and 1	or 1	or 1
LC ⁽³⁾	3P	LC1D09...D38	-	-	1	-	-	
	3P	LC1DT20...DT40	-	-	1	-	-	

(3) LC : Low consumption

Accessories

Description	For use with	Reference	Unit MRP [₹]
For Contactor D115/150			
Contacts set - 3P	LC1D115	LA5D1158031	20240
Contacts set - 3P	LC1D150	LA5D150803	20980
Contacts set - 4P	LC1D1150046	LA5D115804	27900

Product Compatibility	Fixing	Control Circuit Voltage	Suppressor Type	Reference	Unit MRP [₹]
Coil Suppressor Modules					
LC1D12...D25 (4P)	Screw	110...240V AC	RC Circuit AC	LA4DA1U	1585
LC1D12...D25 (4P)		12...250V DC	Diode DC	LA4DC1U	1775
LC1D09...D38, LC2D09...D38, LC1DT20...DT40, LC2DT20...DT40 (3P)		24...48V AC	Varistor AC/DC	LAD4VE	1535
		24...48V AC 400Hz	RC Circuit AC	LAD4RCE	1390
		50...127V AC 200Hz	RC Circuit AC	LAD4RCG	1390
CAD		110...240V AC 100Hz	RC Circuit AC	LAD4RCU <input checked="" type="checkbox"/>	1535
		110...250V AC	Varistor AC/DC	LAD4VU	1535
LC1D80, LC1D95, LC2D80, LC2D95 (3P) LC2D80 (4P), LC1D40008, LC1D65008		24...250V DC	Diode DC	LA4DC3U	1585
		110...250V AC	Varistor AC/DC	LA4DE2U	1515
		24...48V AC 400Hz	RC Circuit AC	LA4DA2E	2390
		50...127V AC 200Hz	RC Circuit AC	LA4DA2G	2390
		110...240V AC 100Hz	RC Circuit AC	LA4DA2U	1585
		380...415V AC 150Hz	RC Circuit AC	LA4DA2N	2390
		24...48V DC	Varistor AC/DC	LA4DE3E	1585

For details on non standard references, technical parameters, accessories, compatibility, stockable and non stockable status please contact Customer Care

NORMAL STOCK ITEMS

W.E.F. January 25th, 2022

Modular marking system simplifies identification of standard contactors in the control panel to enhance visibility of the safety chain

Simple, customisable modular marking system

Standard TeSys Deca contactors

Easy-to-attach covers:



Auxiliary blocks with safety chain identification also available for more contact points:

Standard TeSys Ultra motor starters

Translucent labels to identify safety-chain devices:



Flexibility to customise contactors included in the safety chain during panel building



Simpler and faster maintenance with 100% visibility



Safety covers and auxiliary blocks prevent screwdriver contact with poles

Complete safety-chain identification system

TeSys Deca range

Retrofit contactor safety covers



LAD9ET1S
9A upto 65A



LAD9ET3S
80A to 95A



LAD9ET4S
110A to 150A



LADN22S
2NO + 2NC

TeSys Ultra range

Retrofit identification label



LU9ET1S

Also available for CAD32/CAD50

Built in Safety

TeSys Ultra motor starters are certified according to IEC 60947-4-1 for safety applications thanks to integrated mirror contact

Description	For use with	Reference	Unit MRP [₹]
Red Cover (For safety chain indication)	LC1D09...D65A and DT20 .. DT80A	LAD9ET1S	715
Auxiliary Contact block with red front face- for safety chain indication	2NO + 2NC	LADN22S	1020

For details on non standard references, technical parameters, accessories, compatibility, stockable and non stockable status please contact Customer Care

NORMAL STOCK ITEMS

W.E.F. January 25th, 2022



New TeSys Giga Contactors and Relays Futuristic ready...

- **New generation** of high power contactors..115-800 A (AC-3)
- Advanced contact wear diagnostic for **predictive maintenance**
- **Modular design** for easy maintenance and short down times
- **Compact design** for less installation space consumption
- Less product references for **easier selection** and **reduced inventory**
- Right choice for a wide range of **demanding applications!!**



TeSys Control

TeSys Giga NEW

A comprehensive range of TeSys Giga Contactors that are available in 'Advanced' and 'Standard' versions, in 3 sizes, covering several ratings.
A common range of auxiliary contacts and accessories, enabling high flexibility and simplicity.

> TeSys Giga Contactors - Standard version



Power & control

- 3 or 4 power poles
- 115 to 800A⁽¹⁾ (AC-3)
- 200 to 1050A⁽¹⁾ (AC-1)
- Embedded 1 NO + 1 NC auxiliary contacts
- Push-in type terminals for coils & control

Remote control

- 48-130V, 100-250V AC/DC coils
- Wide voltage range coils (direct coil control)
- Embedded surge-suppressor

Diagnostic

- Embedded wear diagnostic
- Embedded control voltages diagnostic
- Self diagnosis function
- Local alarm signaling (LED)

Mounting

- 'Cabling memory' adapter enables maintenance without removing power cables and busbar connections. (Provided as an accessory in standard version)

> TeSys Giga Contactors - Advanced version



Power & control

- 3 or 4 power poles
- 115 to 800A⁽¹⁾ (AC-3)
- 200 to 1050A⁽¹⁾ (AC-1)
- Embedded 1 NO + 1 NC auxiliary contacts
- Push-in type terminals for coils & control

Remote control

- 24-48V, 48-130V, 200-500V AC/DC coils
- Low consumption coils
- Wide voltage range coils (direct coil control)
- Digital control input (PLC output digital coil control)
- Embedded surge suppressor

Diagnostic

- Embedded wear diagnostic
- Embedded control voltages diagnostic
- Self diagnosis function
- Local alarm signaling (LED)
- Remote wear diagnostic signaling kit (accessory)

Mounting

- 'Cabling memory' adapter enables maintenance without removing power cables and busbar connections. (Provided as default in advanced version)

(1) 630A and 800A (AC-3) and 1050A (AC-1) contactors shall be launched in Q2 2022.

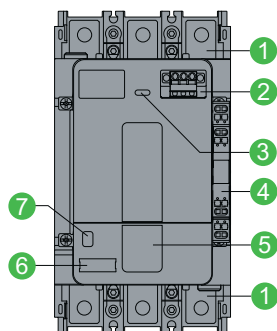

Standard (*N) version

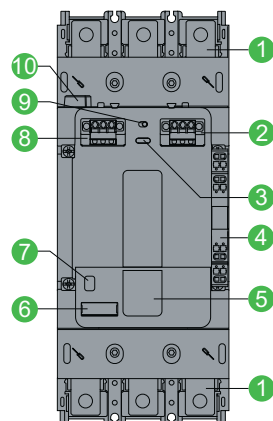

Advanced (*A) version

- 1 Power connection (cable memory kit provided with Advanced version contactor)
- 2 A1-A2 coil terminal
- 3 Contact wear diagnosis LED
- 4 1 NO + 1 NC auxiliary contact
- 5 QR code
- 6 Label holder
- 7 Status indicator
- 8 PLC control terminal
- 9 PLC control ON/OFF switch
- 10 Connector for Remote Wear Diagnostic (RWD) module

*Product references finishing by A or N.

TeSys Giga Power Contactors (3 Pole AC and DC)



Future ready:

Continuous local and remote monitoring of contact wear optimizes the predictive maintenance by allowing you to replace contacts only when necessary, facilitated by diagnostic visual indicator.

- Current Rating: 115-800⁽¹⁾ A AC3 rating; and AC1 upto 1050⁽¹⁾ A
- Universal AC/DC electronic wideband coil
- Fuseless Type 2 Co-ordination charts as per IEC60947-4-1 available
- Conformity to International Standards – IEC, UL, CSA, CE

[Ie] Rated Operational Current AC-1	Motor Power (Long Life) AC-3			Standard version Reference	Unit MRP [₹]	Advanced version Reference	Unit MRP [₹]
	kW	HP	A				
250	59	80	115	LC1G115***N	28000	LC1G115***A	On Request
275	80	110	150	LC1G150***N	35700	LC1G150***A	
305	100	135	185	LC1G185***N	44245	LC1G185***A	
330	110	150	225	LC1G225***N	47610	LC1G225***A	
385	140	190	265	LC1G265***N	57970	LC1G265***A	
440	180	245	330	LC1G330***N	70105	LC1G330***A	
550	220	300	400	LC1G400***N	84730	LC1G400***A	
700	280	380	500	LC1G500***N	117540	LC1G500***A	

(1) 630A and 800A (AC-3) and 1050A (AC-1) contactors shall be launched in Q2 2022.

TeSys Giga Power Contactors (4 Pole AC and DC)

[Ie] Rated Operational Current AC-1	Power Pole Composition	Standard version Reference	Unit MRP [₹]	Advanced version Reference	Unit MRP [₹]
275	4 NO	LC1G1504***N	52610	LC1G1504***A	
305	4 NO	LC1G1854***N	65735	LC1G1854***A	
330	4 NO	LC1G2254***N	77215	LC1G2254***A	
385	4 NO	LC1G2654***N	86335	LC1G2654***A	
440	4 NO	LC1G3304***N	100470	LC1G3304***A	
550	4 NO	LC1G4004***N	124870	LC1G4004***A	
700	4 NO	LC1G5004***N	184010	LC1G5004***A	

Standard Coil Reference(***N)	Voltages (AC/DC)
EHEN	48-130
KUEN	100-250
Standard Coil Reference(***A)	Voltages (AC/DC)
LSEA ⁽¹⁾	200-500
BEEA ^{(1) (2)}	24-48

1: Advanced version (Price on request)

2: Available upto 500 A

Contactors prices are for the standard version (100-250 V AC/DC) and inclusive of coil.

Reference to be completed by adding coil voltage code and recommended to check availability with Customer Care team.

Accessories - TeSys Giga

Add On Blocks	Push In Type Terminal	Position	Contacts	Reference	Unit MRP [₹]
Auxiliary contact module	1st left or 1st right	Side Mounted ⁽¹⁾	1 NO+1NC	LAG8N113P	1245
		Side Mounted	2 NO	LAG8N203P	1616
	2nd left or right	Side Mounted	1 NO+1NC	LAG8N113	1245
		Side Mounted	2 NO	LAG8N203	1616

(1) Always supplied with TeSys Giga LC1G contactors, fitted to the right side lateral face.

Mechanical interlock between contactors ⁽¹⁾	Reference	Unit MRP [₹]
For Use With Contactor		
Between Identical contactor frames	LA9G970	2273
Between LC1G(265-500) and LC1G(185-225)	LA9G971	2273
LC1G630 to LC1G800 and LC1G265 to LC1G500	LA9G972	on request*

(1) Maximum 3 auxiliary contacts can be installed between 2 contactors with mechanical interlock kit.

* to be launched in Q2 2022



EcoStruxure™ Motor Control Configuration



Product Selector for TeSys Giga



EcoStruxure™ Motor Management Design

For details on non standard references, technical parameters, accessories, compatibility, stockable and non stockable status please contact Customer Care

NORMAL STOCK ITEMS

W.E.F. January 25th, 2022

TeSys Control

TeSys F

TeSys F Power Contactors (3 Pole AC/DC Control)



- Conformity to International Standards – IEC, UL, CSA, CE
- High electrical life
- Type 2 Co-ordination Charts available (upon request)
- Common accessories as TeSys Deca
- Rating : 115 - 2600A, AC/DC Coils, special Hoisting application coils
- Shock Proof version and Magnetic latching contactor available

[Ie] Rated Operational Current AC-1	Motor Power (Long Life) AC-3			Reference	Unit MRP [₹]
	kW	HP	A		
200	59	80	115	LC1F115	On Request
250	80	110	150	LC1F150	
275	100	135	185	LC1F185	
315	110	150	225	LC1F225	
350	140	190	265	LC1F265	
400	180	245	330	LC1F330	
500	220	300	400	LC1F400	
700	280	380	500	LC1F500	
1000	375	500	630	LC1F630	
1000	450	610	800	LC1F800	
1250	630	840	1000	LC1F1000	

Note:

- Contactor reference does not include coil. Contactor coil & aux. contacts to be ordered separately.(Coil includes 1NO contact)
- Please select coils from table on next page (Page-30).

TeSys F Power Contactors (2 Pole & 4 Pole AC/DC Control)



- Conformity to International Standards – IEC, UL, CSA
- 2 and 4 pole versions available
- 240-1600A in AC-1 duty, AC/DC coils
- Common accessories same as TeSys Deca
- High electrical life

[Ie] Rated Operational Current AC-1	Power Pole Composition	Reference	Unit MRP [₹]
200	4NO	LC1F1154	On Request
250	4NO	LC1F1504	
275	4NO	LC1F1854	
315	4NO	LC1F2254	
350	4NO	LC1F2654	
400	4NO	LC1F3304	
500	2NO	LC1F4002	
500	4NO	LC1F4004	
700	2NO	LC1F5002	
700	4NO	LC1F5004	
1000	2NO	LC1F6302	
1000	4NO	LC1F6304	
1600	4NO	LC1F7804	

Note:

- Contactor reference does not include coil. Contactor coil & aux. contacts to be ordered separately.(Coil includes 1NO contact)
- Power terminals may be protected by the addition of shrouds, to be ordered separately.

3P AC/DC control for AC-1 applications

[Ie] Rated Operational Current AC-1	Reference	Unit MRP [₹]
1250	LC1F1250	On Request
1700	LC1F1700	
2100	LC1F2100 ⁽¹⁾	
2600	LC1F2600 ⁽²⁾	

(1) With set of right-angled connectors LA9 F2100

(2) With set of right-angled connectors LA9 F2600

It is recommended to check with Customer care team for selection, recommendation ,and availability of stockable and non stockable references

NORMAL STOCK ITEMS

W.E.F. January 25th, 2022

TeSys Control

TeSys F

TeSys F Coils

Product Compatibility	AC Coil Reference	Unit MRP [₹]	DC Coil Reference ⁽²⁾	Unit MRP [₹]
LC1F115, LC1F150	LX9FF*	On Request	LX4FF**	On Request
LC1F185, LC1F225	LX9FG*		LX4FG**	
LC1F265, LC1F330	LX1FH*		LX4FH**	
LC1F400	LX1FJ*		LX4FJ**	
LC1F500	LX1FK*		LX4FK**	
LC1F630	LX1FL*		LX4FL**	
LC1F800	⁽¹⁾		LX4F8**	
LC1F1000, LC1F1700, LC1F2100	LX1FK ⁽³⁾			
LC1F2600	LX1FL ⁽³⁾			

Please replace (*) with the Corresponding Control Voltage.

(1) Use rectifier with required DC coil (Ref: DR5TE4U)

(2) Coil with suppressor fitted as standard.

(3) Set of two coils to be connected in series.

(4) It is recommended to check availability with Customer Care team.

Coil Voltage Code

Type	Voltage (V)	24	110	220	415
AC*	LC1F115-F225, LC1F400-630	-	110	220	415
	LC1F265, LC1F330	-	1102	2202	3802
	LC1F1000		55	110	220
	LC1F1700, 2100, 2600	-	65	110	220
DC**	LC1F115-LC1F330	24	110	220	-
	LC1F400-LC1F780	-	110	220	
	LC1F800	-	FW	MW	

Note: (1) It is recommended to check availability with Customer Care team

Accessories - TeSys Deca and TeSys F

Description	For use With	Position	Contacts	Reference	Unit MRP [₹]
Add On Blocks					
Additional instantaneous auxiliary contact blocks	LC1D09...LC1D150 & LC1F*	Front Mounted	1NO + 1NC	LADN11	500
			2NO	LADN20	
			2NC	LADN02	725
			2NO + 2NC	LADN22	900
			4NC	LADN04	1205
			4NO	LADN40	
	LC1D80...LC1D95* & LC1F		1NO + 3NC	LADN13	900
			3NO + 1NC	LADN31	
			1NO	LADN10*	405
			1NC	LADN01*	

It is recommended to check with Customer care team for selection, recommendation ,and availability of stockable and non stockable references

NORMAL STOCK ITEMS

W.E.F. January 25th, 2022

Accessories - TeSys Deca and TeSys F

Description		Contacts	Reference	Unit MRP [₹]
Add On Blocks				
Additional instantaneous auxiliary contact blocks	Side Mounted ⁽¹⁾	1NO + 1NC	LAD8N11	1740
		2NO	LAD8N20	
Pneumatic timer blocks front mounted	ON delay	1NO + 1NC 0.1..3s	LADT0	3595
		1NO + 1NC 0.1..30s	LADT2	
		1NO + 1NC 10..180s	LADT4	
	OFF delay	1NO + 1NC 1..30s (2)	LADS2 <input checked="" type="checkbox"/>	3835
		1NO + 1NC 0.1 ..3s	LADR0	3595
		1NO + 1NC 0.1 ..30s	LADR2 <input checked="" type="checkbox"/>	
		1NO + 1NC 10 ..180s	LADR4	

(1) Suitable for mounting on D Model range AC Coil Contactors and Control Relays only

(2) With Switching time of 40 ms between opening of the NC contact and closing of the NO contact recommended for Star - Delta Starters

* Suitable for 80A, 95A & Model F contactors only

For Use With TeSys F Contactors	Reference	Unit MRP [₹]
Mechanical Interlocks ⁽¹⁾ - Horizontally Mounted		
LC1F115, LC1F150, LC1F1154, LC1F1504	LA9FF970	On Request
LC1F185, LC1F1854, LC1F225, LC1F2254	LA9FG970	
LC1F265, LC1F330, LC1F400, LC1F500, LC1F2654, LC1F3304, LC1F4004, LC1F5004	LA9FJ970	
LC1F630, LC1F6304, LC1F800	LA9FL970	

(1) For assembly of 3/4 pole 2 contactors of identical rating. To obtain electrical interlocking, please order 2 contact blocks LADN11

All power connections are to be made by the user.

Main Contact Sets*		
LC1F115, LC1F150	LA5FF431 <input checked="" type="checkbox"/>	On Request
LC1F185, LC1F225	LA5FG431	
LC1F265	LA5FH431	
LC1F330, LC1F400	LA5F400803	
LC1F500	LA5F500803	
LC1F630	LA5F630803	
LC1F800	LA5F800803	

* For 3 Pole contactor (per pole: 2 fixed contacts and 1 moving contact, 2 deflectors, 1 backplate, fixing screws & washers.)

Description	For use with	110V Reference	220V Reference	Unit MRP [₹]
Suppressor Blocks				
Suppressor module clip on	All AC ratings	LA4FRCF	LA4FRCP	On Request
Suppressor bracket	For all LA4F	LA9D09981		

Product Compatibility	110V Reference	220/230V Reference	415/440V Reference	Unit MRP [₹]
Hoisting Applications - AC Coils				
LC1F265	LX9FH1102	LX9FH2202	-	On Request
LC1F330				
LC1F400	LX9FJ925	LX9FJ931	LX9FJ937	
LC1F500	LX9FK925	LX9FK931	LX9FK937	
LC1F630	LX9FL924	LX9FL931	LX9FL936	

Note: Rectifier is a must with the coil. Ref no. DR5TE4U for 110..230V & DR5TE4S* for 415..440V, needs to be added extra with coil.

Product Compatibility	48V Reference	110V Reference	220/230V Reference	415/440V Reference	Unit MRP [₹]
Hoisting Applications - DC Coils					
LC1F400	LX9FJ918	LX9FJ926	LX9FJ932	LX9FJ938	On Request
LC1F500	LX9FK918	LX9FK926	LX9FK932	LX9FK938	
LC1F630	LX9FL918	LX9FL926	LX9FL931	LX9FL937	

Note:

- Resistor is a must with every coil as per the quantity mentioned.
- Economy Resistor to be selected from below table as per coil voltage code

Contactor	110V Reference	220V Reference	440/460V Reference	Unit MRP [₹]
Economy Resistor				
	• To be used with hoisting application DC coil			
LC1F400	1 X DR2SC0047	1 X DR2SC1200	1 X DR2SC4700	On Request
LC1F500	1 X DR2SC0039	1 X DR2SC1000	1 X DR2SC3300	
LC1F630	2 X DR2SC0047	2 X DR2SC0047	2 X DR2SC3900	

It is recommended to check with Customer care team for selection, recommendation, and availability of stockable and non stockable references

NORMAL STOCK ITEMS

W.E.F. January 25th, 2022

TeSys Special Purpose Contactor

Capacitor Duty Contactor



Nominal Reactive Power 440V	Auxiliary Contacts	Reference	Unit MRP [₹]
LC1-D•K - with Damping Resistors & Block of Early Make poles			
12.5 kVar	1NO + 2NC	LC1DFK*	4850
16.7 kVar	1NO + 2NC	LC1D GK*	6815
20 kVar	1NO + 2NC	LC1DLK*	7655
25 kVar	1NO + 2NC	LC1DMK*	8395
32 kVar	1NO + 2NC	LC1DPK*	18290
40 kVar	1NO + 2NC	LC1DTK*	25195
60 kVar	1NO + 2NC	LC1DWK12*	28365

Contactor recommended upto 6 steps. For over 6 steps it is recommended to use chokes

* Reference to be completed by adding coil voltage code

Coil Voltage Code

VOLTAGE	110	220
LC1DFK....DWK, 50/60Hz	F7	M7

Note:

- (1) For non standard coil voltage (including F7) prices please consult customer care.
- (2) It is recommended to check availability with Customer Care team.



Instruction Manual
Video for Capacitor
Duty Contactors



Guide for the Design
and Production of LV
Power Factor
Correction Cubicles

For complete information on selection of capacitor switching please refer to the TeSys catalogue

It is recommended to check with Customer care team for selection, recommendation ,and availability of stockable and non stockable references

NORMAL STOCK ITEMS

W.E.F. January 25th, 2022

TeSys H - Ultra Compact Hybrid Motor Starters

The most compact 3 KW / 400 V starter in the world



Up to 75 % of space reduction

- Ultra-compact 22.5 mm starter
- Reversing starter in the same width
- Maximum space savings for group starter architecture

Long electrical durability

- Suitable for high demanding application
- 30 000 000 of AC53a electrical cycles

> With printed QR code, referring directly to the product data sheet.

Easy Design

- Wide range setting motor protection
- Automatic, manual or remote reset after thermal trip
- Wide range of control voltage

Easy to integrate

- Direct mounting installation on DIN rail
- Control terminals on the upper side
- Power terminal on the lower side

It is recommended to check with Customer care team for selection, recommendation, and availability of stockable and non stockable references









☑ NORMAL STOCK ITEMS

W.E.F. January 25th, 2022

TeSys Protection Range

TeSys has the most rugged and reliable solution to manage motors

Please find a quick range overview below

	TeSys Power		TeSys Protect				TeSys Active		
Feature	Motor Protection Circuit Breakers		Overload Relays		Multi function Relays		TeSys Ultra	TeSys T	TeSys Island
TeSys Range of Products	GV2P, GV4P GV3P, GV2ME	GV4PEM	LR2K, LRD, LR9D, LR9F	LR9G	EOCR				
									
Short circuit									
Causes of overheating									
Slight overload									
Locked rotor									
Ventilation fault With probes							With Probes	With Probes	
Abnormal temperature rise								With Probes	
Shaft bearing seizure									
Insulation fault					With CBCT				
Long starting time Adjustable Adjustable		Adjustable			Adjustable	Adjustable	Adjustable	Adjustable	
Heavy duty			LR9D only						
Voltage variation (Derived)									
Causes of phase variation									
Phase reversal									
Phase losses									
Phase imbalance									
Earth fault	GV4P only								
Historic fault, Pre-Alarming					Possible Pre alarm				

Protection Relays for Motor Safety

Providing Motor Safety
tailored to your needs



TeSys Protect

TeSys K, TeSys Deca, TeSys F, TeSys Giga

Thermal Overload Relays - TeSys K Series (Direct Mounting)



- Conformance to IEC, UL, CSA, CE
- Range : 0.1A to 16A
- Direct & Independent mounting
- Trip class 10A

Thermal Protection Adjustment	For Use With	For Use With	Unit MRP [₹]	
0.11...0.16	LC1K, LP1K, LP4K, LP2K, LC2K	LR2K0301	2340	
0.16...0.23		LR2K0302		
0.23...0.36		LR2K0303		
0.36...0.54		LR2K0304		
0.54...0.8		LR2K0305		
0.8...1.2		LR2K0306		
1.2...1.8		LR2K0307		
1.8...2.6		LR2K0308		
2.6...3.7		LR2K0310		
3.7...5.5		LR2K0312		
5.5...8		LR2K0314		
8...11.5		LR2K0316		
10...14		LR2K0321		
12...16		LR2K0322		2380

*Note: Terminal Block for Clip-on Mounting LA7K0064

Thermal Overload Relays - TeSys Deca Series



- Conformance to IEC, UL, CSA
- Range : 0.1A to 104A
- Higher operating temperature
- Tripping class 10A & 20 available
- Direct mounting on contactor is possible upto 95A

Thermal Protection Adjustment Range	For Use With	Reference*	Unit MRP [₹]		
LRD Model (Direct Mounting)					
0.1...0.16	GV2L03, LE03, LC1D09...LC1D38	LRD01	2350		
0.16...0.25		LRD02			
0.25...0.4		LRD03			
0.4...0.63		LRD04			
0.63...1		LRD05 ✓			
1...1.6		LRD06 ✓			
1.6...2.5		LRD07 ✓			
2.5...4		LRD08 ✓			
4...6		LRD10 ✓			
5.5...8		LRD12 ✓			
7...10		LRD14 ✓			
9...13		LRD16 ✓			
12...18		LRD21 ✓			
16...24		GV2L22, LC1D25...D38		LRD22 ✓	2720
23...32		LC1D25...LC1D38, LC1D32		LRD32 ✓	4370
30...38		LC1D32, LC1D38	LRD35		
23...32	LC1D40A...D65a	LRD332	4840		
30...40	LC1D80...LC1D95	LRD3353			
30...40	LC1D40A...D65a	LRD340			
30...40	LC1D80...LC1D95	LRD3355			
37...50	LC1D40A...D65a	LRD350 ✓	6635		
	LC1D80...LC1D95	LRD3357	7935		
48...65	LC1D40A...D65a	LRD365	8515		
62...80	LC1D80A	LRD380	8880		
48...65	LC1D80...LC1D95	LRD3359	8515		
63...80	LC1D80...LC1D95	LRD3363	9240		
80...104	LC1D80, LC1D95	LRD3365	11405		

Electronic Overload Relay - TeSys Deca Series



- Conformance to IEC, UL, CSA
- Range : 0.1A to 32A
- 5:1 Adjustment range
- High Operating Temperature
- Field selectable tripping class : 5,10, 20 & 30
- Type 1 & Type 2 Co-ordination chart available

Current Range	For Use With	Reference*	Unit MRP [₹]
0.1...0.5	LC1D09 - 38A Direct Mounting	LR9D01	10680
0.4...2.0		LR9D02	10965
1.6...8.0		LR9D08	
6.4...32		LR9D32	12265

*Note: For LR9D01 to LR9D32 - Terminal Block for Clip on Mounting LAD7B205.

Electronic Overload Relay - TeSys F Series



- Conformity to International Standards - IEC, UL, CSA
- Direct mounting on contactors is possible upto 630A
- Higher operating temperature
- Tripping class 10

Thermal Protection Adjustment Range	Reference*	Unit MRP [₹]
LRD Model (Direct Mounting)		
90...150	LR9F5369 ✓	On Request
132...220	LR9F5371	
200...330	LR9F7375	
300...500	LR9F7379	
380...630	LR9F7381	

Electronic Overload Relay - TeSys Giga Series NEW



- Wide range of protection with only 4 references (28A to 630A)
- Switchable protection against ground fault and phase imbalance
- ON status and overload alarm signaling by LED
- Direct mounting of relay with contactors saving in panel space and installation time
- Selectable Trip class from 5E to class 30E to suit different application needs

Thermal Protection Adjustment Range	Reference	Unit MRP [₹]
28...115 A	LR9G115	18000
57...225 A	LR9G225	21000
125...500 A	LR9G500	24700
160...630 A	LR9G630*	on request

*To be launched in Q2 2022

*Note:

- For LRD01...LRD35 - Terminal Block for clip-on Mounting LAD7B106
- For LRD33** - Terminal Block for clip-on Mounting LA7D3064 ✓
- For LRD332, LRD340, LRD350 & LRD365 - Connection block for separate mounting LAD96560
- The LRD relays can be used for AC or DC current up to 104A
- For long starting, Class 20 relays are available on request.
- Device for remote tripping and electrical reset is available on request.

For details on non standard references, technical parameters, accessories, compatibility, stockable and non stockable status please contact Customer Care

✓ NORMAL STOCK ITEMS

W.E.F. January 25th, 2022

Advanced Motor Protection

High performance protection
for your application



EOLR Electronic Overload Relay

- Precise Overload Protection
- Wide operating Range 5:1
- Higher Operating Temperature
- Selectable Trip Class



EOCR Electronic Over Current Relay

- Compact and Robust
- Advanced current protections
- Suitable for 1-phase and 3-phase applications
- Suitable for motors upto 400A
- Pass-through CT for electrical isolation

TeSys Protect

EOLR, EOCR

EOLR

Electronic Overload Relay

- Conformance to IEC, UL, CSA
- Range : 0.1A to 630A
- High Operating Temperature
- Field selectable tripping class : 5,10, 20 & 30
- Type 1 & Type 2 Co-ordination chart available

Current Range	For Use With	Reference*	Unit MRP [₹]
LR9-D Electronic Protection Relays			
0.1...0.5		LR9D01	10680
0.4...2.0	LC1D09 - 38A Direct Mounting	LR9D02	10965
1.6...8.0		LR9D08	
6.4...32		LR9D32	12265
LR9-G Electronic Protection Relays			
28...115		LR9G115	18000
57...225	LC1G115 - 630A Direct Mounting	LR9G225	21000
125...500		LR9G500	24700
160...630		LR9G630	On Request

Note: For LR9D01 to LR9D32 - Terminal Block for Clip on Mounting LAD7B205.

Analog EOCR

- Compact
- Protection against over current/phase loss/locked rotor (phase loss/locked rotor operates by over current)
- Manual (instant)/electrical reset
- NVR (No Volt Release) function / Fail Safe
- Suitable for single-phase / 3-phase motors
- LED (operation display and active current display)

EOCR SS

- Without Display



EOCR SS			
Current Range	Control Voltage	Reference	Unit MRP [₹]
0.5-6	24-240V AC/DC	EOCRSS-05S	6105
3-30	24-240V AC/DC	EOCRSS-30S	
5-60	24-240V AC/DC	EOCRSS-60S	

Note: 2 SPST output contacts

To order an EOCR-SS:

E 0 C R S S - 0 5 S

1 2

1	Current Setting Range	5	0.5-6A	For 60A or higher, combine 05 Type and an external CT (secondary 5A) for use
		30	3.0-30A	
		60	5.0-60A	
2	Operating Power Supply	S	24-240V AC/DC	
		W	380-440V AC	

Note: For a CT combination type, please write an accessory code from the CT Order Codes separately.

Protection Relay Selection Table

Features/product	EOLR		EOCR	
	LR9D/LR9G	SS/SSD	3DM2/FDM2	3MZ2/FMZ2/3BZ2/FBZ2
Precise Overload Protection (Inverse Time)				
Over Current Protection (Definite Time)				
Selectable Trip Clas 5-30				
Current Unbalance Protection	LR9G Only			
Locked Rotor, Phase Loss		*		
Under current Protection				
Ground Current Protection	LR9G Only			
Current Measurement	3CT	2CT	3CT	3CT
Current Display		#		
Direct Mounting on Contactor	\$			
Fault History				
Configurable protection functions				

* - over current based protection

- with SSD

\$ - upto 38 Amps

Possible solution

Ideal solution

EOCR SSD

- With Display (Operating Current & Trip Cause)



EOCR SSD			
Current Range	Control Voltage	Reference	Unit MRP [₹]
0.5-6	24-240V AC/DC	EOCRSSD-05S	9130
3-30	24-240V AC/DC	EOCRSSD-30S	
5-60	24-240V AC/DC	EOCRSSD-60S	

Note: 2 SPST output contacts

To order an EOCR-SS:

E 0 C R S S D - 0 5 S

1 2

1	Current Setting Range	5	0.5-6A	For 60A or higher, combine 05Type and an external CT (secondary 5A) for use
		30	3.0-30A	
		60	5.0-60A	
2	Operating Power Supply	S	24-240V AC/DC	
		W	380-440V AC	

Note: For a CT combination type, please write an accessory code from the CT Order Codes separately.

For details on non standard references, technical parameters, accessories, compatibility, stockable and non stockable status please contact Customer Care

NORMAL STOCK ITEMS

W.E.F. January 25th, 2022

TeSys Protect EOCR

NEW

Digital EOCR



Selection Table for Digital EOCR

3 **D** **M** **2** - **W** **R** **D** **U** **W** **Z**

1 2 3 4 5 6

1	Digital Electronic Over-current Relay	3DM2/ FDM2	Without Ground Fault Protection
		3MZ2/ FMZ2	With Ground Fault Protection with External ZCT
		3BZ2/ FBZ2	With Ground Fault Protection inbuilt ZCT
Built-in display		3●●2	Flush mounting display F●●2
No	Item	Type	Current Range
2	Standard	WR	0.5...80A
3	Relay Output	D	b (95-96), a(97-98), a(07-08) 3DM2, FDM2
		A	a(97-98): OL, a(57-58): GF
		C	b(95-96), a(97-98): OL/GF
		D	b(95-96) : OL, a(57-58): GF*
4	Control Power	B	AC/DC 24V
		U	AC/DC 100~240V
5	Wiring Method	W	Window-hole type*
		H	Bottom-hole type
6	Version	Z	New version

* Not Possible with 3BZ2/FBZ2

- Micro-controller unit based
- Real time processing / High precision
- Protections : Over current, Under current, Phase loss, Phase reversal, Stall, Jam, Current Imbalance, Earth fault (3MZ2/FMZ2/3BZ2/FBZ2)
- Current Rating - 0.5 to 400A
- Bar graph indication of a load current to the current setting.
- Ancillary functions : Fail safe, Accumulated running hour, 3 faults records & limitation of auto-restart.
- Individual phase I-THD monitoring
- Suitable low Frequency Operation
- Communication capable RS485 (Optional)

Digital EOCR				
Current Range	Control Voltage	Reference	Description	Unit MRP [₹]
0.5-80A	100-240V AC/DC	3DM2-WRDUWZ		19265
		3DM2-WRDUHZ	Without ground - fault protection	20835
		FDM2-WRDUWZ		
		FDM2-WRDUHZ		
		3MZ2-WRAUWZ		19525
		3MZ2-WRAUHZ		
		3MZ2-WRCUWZ		
		3MZ2-WRCUHZ		
		3MZ2-WRDUWZ		
		3MZ2-WRDUHZ	With ground - fault protection	
		FMZ2-WRAUWZ		23440
		FMZ2-WRAUHZ		
		FMZ2-WRCUWZ		
		FMZ2-WRCUHZ		
		FMZ2-WRDUWZ		
		FMZ2-WRDUHZ		
3BZ2-WRAUHZ		28340		
3BZ2-WRCUHZ	With ground - fault protection (inbuilt ZCT)			
FBZ2-WRAUHZ				
FBZ2-WRCUHZ		28795		

EOCR Accessories

ZCT - Ground Fault Protection			
	Reference	Description	Unit MRP [₹]
	ZCT-035-Z	ZCT EP 35 mm	6130
	ZCT-080-Z	ZCT EP 80 mm	8295
	ZCT-120-Z	ZCT EP 120 mm	13650

Display Cable for FDM2/FMZ2/FBZ2			
	Reference	Description	Unit MRP [₹]
	CABLE-RJ45-001Q	CABLE 1M	2230

ZCT - Ground Fault Protection			
3CT - H1 - 100 - Z			
1			

	Reference	Description	Unit MRP [₹]
	H1-100-Z	Square 3CT 100:5	4905
	HH-150-Z	Square 3CT 150:5	6075
	H2-200-Z	Square 3CT 200:5	6730
	H3-300-Z	Square 3CT 300:5	7050
	H4-400-Z	Square 3CT 400:5	8295

For details on non standard references, technical parameters, accessories, compatibility, stockable and non stockable status please contact Customer Care

NORMAL STOCK ITEMS

W.E.F. January 25th, 2022

TeSys Power

Circuit breakers for Motor protection

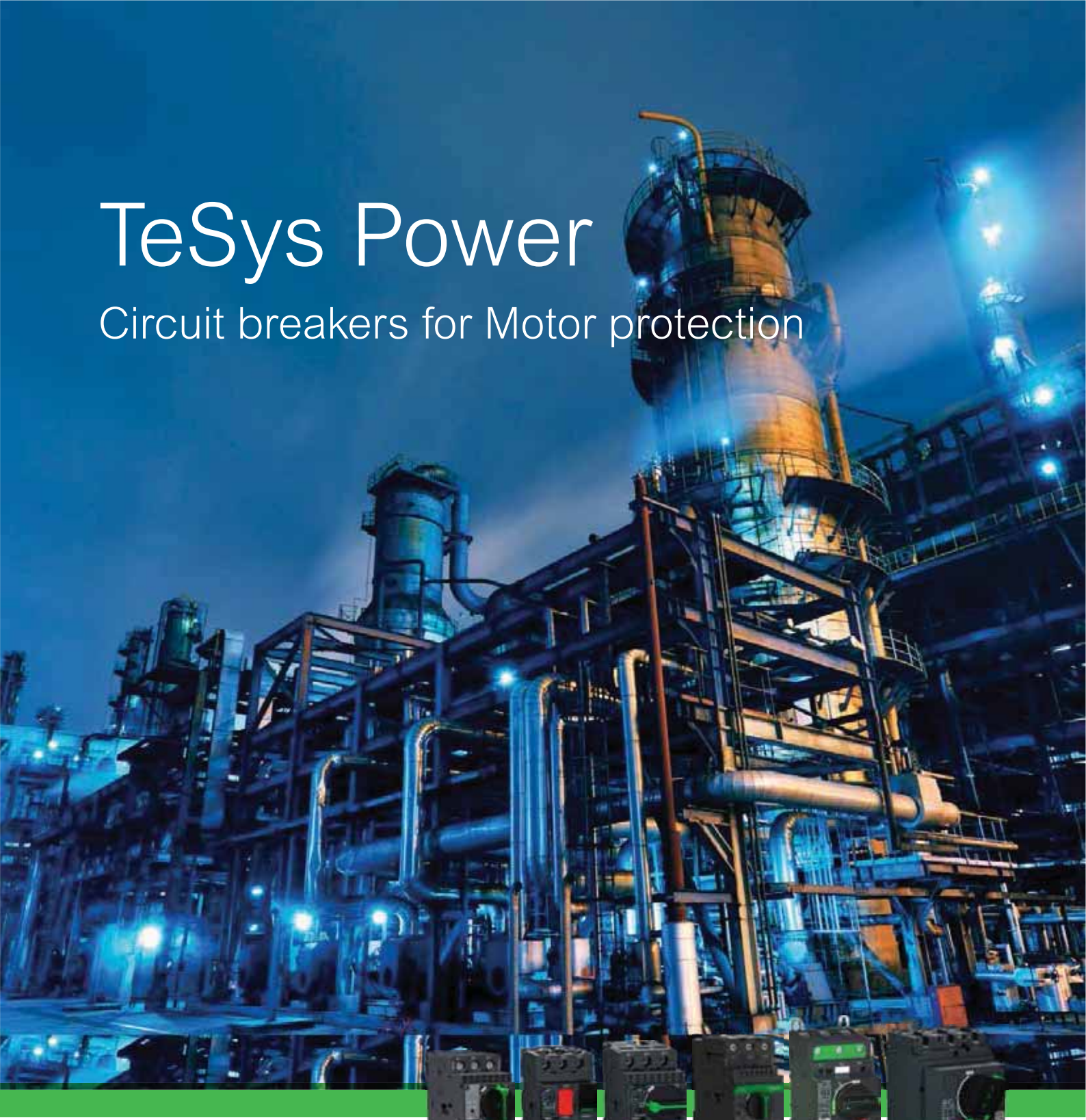

Circuit breakers for motor protection and control

TeSys Deca and TeSys Giga Circuit Breakers provide compact, reliable and efficient solutions:

- Isolation
- Protection against short circuits and overloads
- Control of motors from 0.06 to 250 kW.
- Conforming to global standards.(IEC/EN/UL/CSA)



For more information
on motor protection
circuit breakers

se.com/in/TeSys

TeSys Power

Circuit Breakers for Motor Protection

Magnetic Circuit Breaker



- Conformance to IEC 60947 -1,-2,-4
- Magnetic circuit breakers range from 0.1-80 Amps
- High Breaking capacity up to 100kA
- Wide range of accessories

Breaking Capacity at 415V 50Hz	Motor Power AC-3**		Magnetic Protection Rating (A)	Reference	Unit MRP [₹]
	kW	HP			
With Rocker Lever Control (Economy)*					
100kA	0.09	-	0.4	GV2LE03	4875
	0.18	-	0.63	GV2LE04	
	0.37	0.5	1	GV2LE05	
	0.55	-	1.6	GV2LE06	
	1.1	1.5	2.5	GV2LE07	
	1.5	2	4	GV2LE08	
	2.2	3	6.3	GV2LE10	
	3	5.5	10	GV2LE14	
15kA	5.5	7.5	14	GV2LE16	5660
	7.5	10	18	GV2LE20	
10kA	11	15	25	GV2LE22	9615
	15	20	32	GV2LE32	
With Rotary Handle Control*					
100kA	0.09	-	0.4	GV2L03	5595
	0.18	-	0.63	GV2L04	
	0.37	0.5	1	GV2L05	
	0.55	-	1.6	GV2L06	
	1.1	1.5	2.5	GV2L07	
	1.1	2	4	GV2L08	
	2.2	3	6.3	GV2L10	
	4	5.5	10	GV2L14	
50kA	5.5	7.5	14	GV2L16	15775
	7.5	10	18	GV2L20	
	11	15	25	GV2L22	
	15	20	32	GV2L32	
	18.5	25	40	GV3L40	
	22	29	50	GV3L50	
	30	40	65	GV3L65	
	37	50	73	GV3L73	
With Toggle Control					
50kA	37	50	80	GV4LE80N6	15525
	55	74	115	GV4LE115N6	
	75	101	150	LV430832	On Request
	110	147	220	LV431752	
	160	214	320	LV432749	
	200	268	500	LV432949	

* Conforming to IEC 60947-2-3-4

** 50/60Hz - 415V

• GV2-L with the TeSys Deca contactor and LRD overload relay provides Type 2 Co-ordination

** 50/60Hz - 415V

(1) With GV1-L3 current limiter, breaking capacity can be increased to 100kA. Combination of the GV2-M with the TeSys Deca provides Type 2 Co-ordination.

(2) With GV1-L3 current limiter, breaking capacity can be increased to 100kA. Combination of the GV2-P with the TeSys Deca provides Type 2 Co-ordination.

Thermal Magnetic Circuit Breaker



- Conformance to IEC 60947 -1,-2,-4, conformity to International Standards - UL, CSA, CE
- Thermal magnetic circuit breakers range from 0.1-220 Amps
- High Breaking capacity up to 100kA
- Wide range of accessories
- S-shaped busbar for side-by-side connection with 40 - 65A Contactor

Breaking Capacity at 415V 50Hz	Motor Power AC-3**		Thermal Protection Adjustment Range	Reference	Unit MRP [₹]
	kW	HP			
With Push Button Control (Economy)					
100kA	-	-	0.1 - 0.16	GV2ME01	5235
	0.06	-	0.16 - 0.25	GV2ME02	
	0.09	-	0.25 - 0.40	GV2ME03	5565
	0.18	-	0.40 - 0.63	GV2ME04 ✓	
	0.37	0.5	0.63 - 1.0	GV2ME05 ✓	5690
	0.55	0.75	1.0 - 1.6	GV2ME06 ✓	
	0.75	1	1.6 - 2.5	GV2ME07 ✓	5885
	1.1	2	2.5 - 4	GV2ME08 ✓	
15kA ⁽¹⁾	2.2	3	4 - 6.3	GV2ME10 ✓	6600
	3	5.5	6 - 10	GV2ME14 ✓	
	5.5	7.5	9 - 14	GV2ME16 ✓	7100
	7.5	10	13 - 18	GV2ME20 ✓	
10kA ⁽¹⁾	9	12.5	17 - 23	GV2ME21 ✓	7580
	11	15	20 - 25	GV2ME22 ✓	7580
	15	20	24 - 32	GV2ME32 ✓	12280
With Rotary Handle Control					
100kA	-	-	0.1 - 0.16	GV2P01	5095
	0.06	-	0.16 - 0.25	GV2P02	
	0.09	-	0.25 - 0.40	GV2P03	5840
	0.18	-	0.40 - 0.63	GV2P04	
	0.37	0.5	0.63 - 1.0	GV2P05 ✓	6020
	0.55	0.75	1.0 - 1.6	GV2P06	
	0.75	1	1.6 - 2.5	GV2P07	6420
	1.1	2	2.5 - 4	GV2P08 ✓	
	2.2	3	4 - 6.3	GV2P10 ✓	7885
	3	5.5	6 - 10	GV2P14 ✓	
50kA ⁽²⁾	5.5	7.5	9 - 14	GV2P16 ✓	9105
	7.5	10	13 - 18	GV2P20 ✓	
	9	12.5	17 - 23	GV2P21 ✓	15340
	11	15	20 - 25	GV2P22 ✓	
35kA ⁽²⁾	15	20	24 - 32	GV2P32 ✓	17925
	18.5	30...40	30...40	GV3P40 ✓	
	22	37...50	37...50	GV3P50 ✓	22225
50kA	30	48...65	48...65	GV3P65 ✓	22795
	37	62...73	62...73	GV3P73	23300
With Toggle Control					
50kA	37	49.58	40...80	GV4PE80N6	20125
	55	73.7	65...115	GV4PE115N6	
With Direct Rotary Handle					
70kA	75	101	70...150	GV5P150H	42085
	110	147	100...220	GV5P220H	49095
	160	214	160...320	GV6P320H	63125
	200	268	250...500	GV6P500H	86970

It is recommended to check with Customer care team for selection, recommendation, and availability of stockable and non stockable references

✓ NORMAL STOCK ITEMS

W.E.F. January 25th, 2022

TeSys Power

Circuit Breakers for Motor Protection

GV4LE



- IEC/EN 60947-1, IEC/EN 60947-2, CCC, EAC
- Can be used with class 5, 10 or 20 relay
- Short Circuit Protection with an adjustable pick-up $I_n = 6$ to 14 In.
- From 0.25 - 55kW

Magnetic Toggle Control

Motor Power AC-3 (400/415V AC)		In	Magnetic Setting Range	25kA Breaking Capacity		50kA Breaking Capacity		100kA Breaking Capacity	
kW	HP	(A)	A	Reference	Unit MRP [₹]	Reference	Unit MRP [₹]	Reference	Unit MRP [₹]
0.25..0.75	0.3..1	2	12..28	-	-	GV4LE02N6	12420	GV4LE02S6	15870
0.55..1.5	0.7..2	3.5	21..49	-	-	GV4LE03N6		GV4LE03S6	
1.5..3	2.4	7	42..96	-	-	GV4LE07N6		GV4LE07S6	
3..5.5	4..7.5	12.5	75..175	-	-	GV4LE12N6		GV4LE12S6	
5.5..11	7.5..14	25	150..350	GV4LE25B6	On Request	GV4LE25N6	15525	GV4LE25S6	18975
11..22	15..30	50	300..700	GV4LE50B6		GV4LE50N6		GV4LE50S6	
18.5..37	25..50	80	480..1120	GV4LE80B6		GV4LE80N6		GV4LE80S6	
30..55	40..75	115	690..1610	GV4LE115B6		GV4LE115N6		GV4LE115S6	

Note: For Everlink termination please order after removing the 6 at the end Eg. GV4LE115N

GV4PE



- IEC/EN 60947-1, IEC/EN 60947-2, IEC/EN 60947-4-1, UL 60497-4-1, CCC, EAC, CSA
- Overload or thermal protection
- Short time delay protection
- Short circuit protection
- Fixed Ground fault protection
- Phase unbalance or phase loss
- Front indications through LED
- Variable Trip class : Trip Class 10/ Trip Class 20

Thermal Magnetic Protection Toggle Control

Motor Power AC-3 (400/415V AC)		In	Magnetic Setting Range	25kA Breaking Capacity		50kA Breaking Capacity		100kA Breaking Capacity	
kW	HP	(A)	A	Reference	Unit MRP [₹]	Reference	Unit MRP [₹]	Reference	Unit MRP [₹]
0.25..0.75	0.3..1	2	0.8..2	-	-	GV4PE02N6	17020	GV4PE02S6	18400
0.55..1.5	0.7..2	3.5	1.4..3.5	-	-	GV4PE03N6		GV4PE03S6	
1.5..3	2.4	7	2.9..7	-	-	GV4PE07N6		GV4PE07S6	
3..5.5	4..7.5	12.5	5..12.5	-	-	GV4PE12N6		GV4PE12S6	
5.5..11	7.5..14	25	10..25	GV4PE25B6	On Request	GV4PE25N6	20125	GV4PE25S6	22425
11..22	15..30	50	20..50	GV4PE50B6		GV4PE50N6		GV4PE50S6	
18.5..37	25..50	80	40..80	GV4PE80B6		GV4PE80N6		GV4PE80S6	21275
30..55	40..75	115	65..115	GV4PE115B6		GV4PE115N6		GV4PE115S6	

Note: For Everlink version please order after removing the 6 at the end. Eg. GV4PE115N

Crimp Lug/busbar connection			
Description	Sold in lots of	Reference	
Crimped lug connector + screws	1	GV4LUG	
Transparent terminal shield for crimped lug connector	1	LAD96590	
Interphase barriers	6	LV426920	
Spreader 3-pole	To increase the pitch to 35 min	1	LV426940

It is recommended to check with Customer care team for selection, recommendation, and availability of stockable and non stockable references

NORMAL STOCK ITEMS

W.E.F. January 25th, 2022

TeSys Power

Circuit Breakers for Motor Protection

Accessories for GV4



MX Shunt Trip

- Trips the circuit breaker when the control voltage rises above 70% of rated voltage
- Shunt trip 110..130V AC is suitable.. etc for ground fault protection when combined with a Class I ground fault sensing element

MN Under Voltage Release

Trips the circuit breaker when the control voltage drops below 35% of its rated voltage

Description	Mounting	Voltage	References	Unit MRP [₹]
Mx Shunt Trip	Internal, Plug-In	220-240 VAC 50 Hz, 208-240 VAC 60 Hz, 277 VAC 60 Hz	GV4AS287	3465
Mn Under Voltage Release	Internal, Plug-In	440-480 VAC 60 Hz	GV4AU486	5125

Auxiliary Contact Blocks



An auxiliary contact block provides one changeover contact with one common point for OF and SD function, depending on where it is inserted

Open/Close OF Function: indicates position of the circuit breaker contacts

Trip Alarm SD Function: indicates circuit breaker tripping due to:

- Electrical fault (overload, short circuit)
- Shunt trip/Undervoltage release
- "Push to Trip" Function

Resets when the circuit breaker is reset

Description	Maximum Number	Mounting	Type of Contacts	Reference	Unit MRP [₹]
Auxiliary Contact Block	2 (1 Each For OF or SD)	Internal Plug-In	NO + NC	GV4AE11	1220

Rotary Handles

Description	Type	Degree of Protection	Reference	Unit MRP [₹]
Direct Mounting Rotary Handle	BLACK	IP40	GV4ADN01	1815
	BLACK	IP54	GV4APN01	
Front Extended Rotary Handle (Min Shaft Length 214Mm/Max Shaft Length 627Mm)	RED HANDLE ON YELLOW BEZEL	IP54	GV4APN02	2695
	RED HANDLE ON YELLOW BEZEL	IP65	GV4APN04	2835

Connection Accessories

Description	Reference
Spreader 3-pole (To increase pitch to 35mm) (1 pce)	LV426940

It is recommended to check with Customer care team for selection, recommendation, and availability of stockable and non stockable references

NORMAL STOCK ITEMS

W.E.F. January 25th, 2022

TeSys Power

Circuit Breakers for Motor Protection

Accessories for Motor Circuit Breakers

Description	Reference	Unit MRP [₹]
For GV2		
Front contact NO or NC ⁽¹⁾	GVAE1	1070
Front contact NO + NC	GVAE11 <input checked="" type="checkbox"/>	1315
	GVAE20	1450
Side contact NO + NC	GVAN11 <input checked="" type="checkbox"/>	1585
	GVAN20	
Fault signalling contact + 1NO contact ⁽²⁾	GVAD1010 <input checked="" type="checkbox"/>	2065
Fault signalling contact + 1NC contact ⁽²⁾	GVAD1001	
Short circuit signalling contact block 1 C/O	GVAM11	1970
Under voltage trip	110 ... 115V 50Hz	GVAU115
	220 ... 240V 50Hz	GVAU225
	380 ... 400V 50Hz	GVAU385
Shunt trip	110 ... 115V 50Hz	GVAS115
	220 ... 240V 50Hz	GVAS225
	380 ... 400V 50Hz	GVAS385
Additive limiter for increasing breaking capacity to 100kA for GV2ME and GV2P.	GV1L3	6085
Connection block - GV2 with contactor LC1-D09..D38	GV2AF3	740
Connection block - LS1 D32 or GV2 with Contactor LC1-K or LP1-K	GV2AF01	800
Empty enclosure for GV2ME - plastic	GV2MP02	3165
	GV2MC02	3475

(1) Choice of NC or NO contact operation depending on which way round the reversible block is mounted.

(2) The GV-AD is always mounted next to the circuit breaker.

Busbars

Connection Pitch	No. of Tapoff Points	Reference	Unit MRP [₹]
For GV2			
45 mm	2	GV2G245	1865
	4	GV2G445	2935
54 mm	2	GV2G254	1885
	3	GV2G354	2120
	4	GV2G454	2655
72 mm	5	GV2G554	2875
	4	GV2G472	3250

Description	Reference	Unit MRP [₹]
Accessories for Busbars		
Terminal block - to supply one or more 3-pole busbar GV2	GV2G05	4075
Protective end covers for unused busbar outlets	GV1G10	720
Terminal block for connection from top	GV1G09	2130

Accessories for Motor Circuit Breakers

Description	Reference	Unit MRP [₹]
For GV2-P/GV2-L		
External operator - IP54, Black	GV2APN01 <input checked="" type="checkbox"/>	3780
External operator - IP54, Yellow/Red	GV2APN02	6965
Visible isolation block - for motor circuit breaker GV2	GV2AK00	3165
For GV3P/GV3L		
Auxiliary Contacts		
Front contact: 1 NO (fault) + 1NC (Auxiliary)	GVAED011	1365
Front contact: 1 NO (fault) + 1NO (Auxiliary)	GVAED101	1500
Busbar		
3-pole, 3 tap, 64 mm pitch	GV3G364	1790
S-shape bus bar	GV3S	1340
External Operator		
IP54, Black	GV3APN01	4515
IP54, Yellow/Red	GV3APN02	4330

Note: All other accessories are same as of GV2.

Busbars GV3G364 and GV3S are not compatible with GV3*73 and GV3*80.

Description	Operating Voltage	Reference	Unit MRP [₹]
For GV5 and GV6			
Auxiliary contact - 1 OC	-	GV7AE11 <input checked="" type="checkbox"/>	2840
Clip-on connector - upto 150 A - 1.5..95 mm ²	-	GV7AC021	1170
Clip-on connector- upto 220 A - 1.5..185 mm ²	-	GV7AC022	1245
Front rotary handle	-	GV7AP03	4880
GV7AP GV7R - black handle ⁽²⁾	-	GV7AP01	8490
Padlocking device - 1..3 padlocks Ø 5..8mm shank ⁽³⁾	-	GV7V01	1155
Terminal shields IP405 ⁽¹⁾	-	GV7AC01	3020

For GV5 and GV6

Shunt release	200...240 V AC 50/60 Hz	GV7AS207	6450
Under Voltage release	200...240 V AC 50/60 Hz	GV7AU207	6660

(1) Terminal shields cannot be used together with spreaders.

(2) For mounting direct rotary handle on enclosure door.

This accessory makes it possible to open the door if the device is closed and prevents the device from being closed if the door is open.

(3) For Circuit breaker not fitted with a rotary handle

It is recommended to check with Customer care team for selection, recommendation, and availability of stockable and non stockable references

NORMAL STOCK ITEMS

W.E.F. January 25th, 2022

TeSys

Accessories compatibility

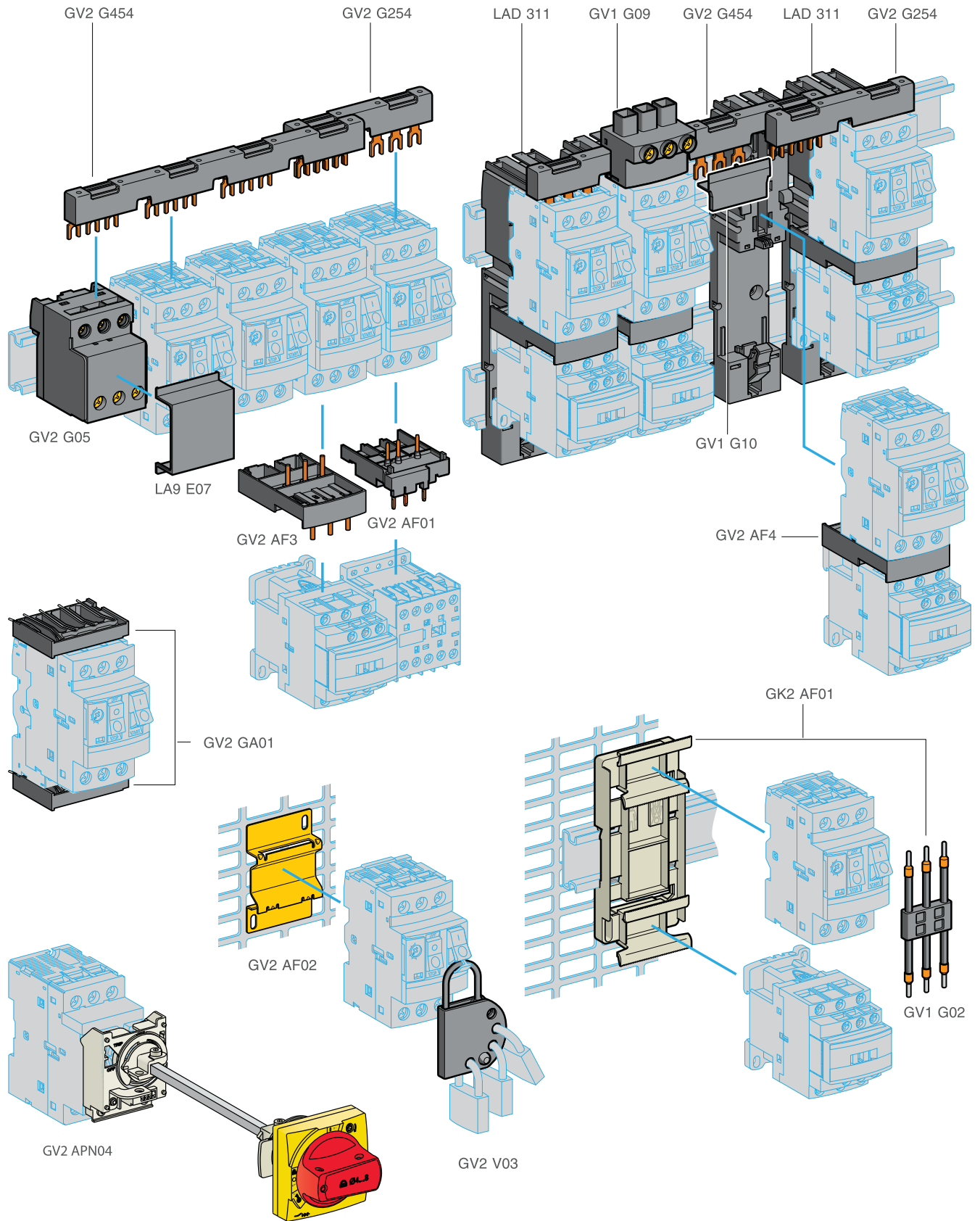

TeSys

Accessories compatibility

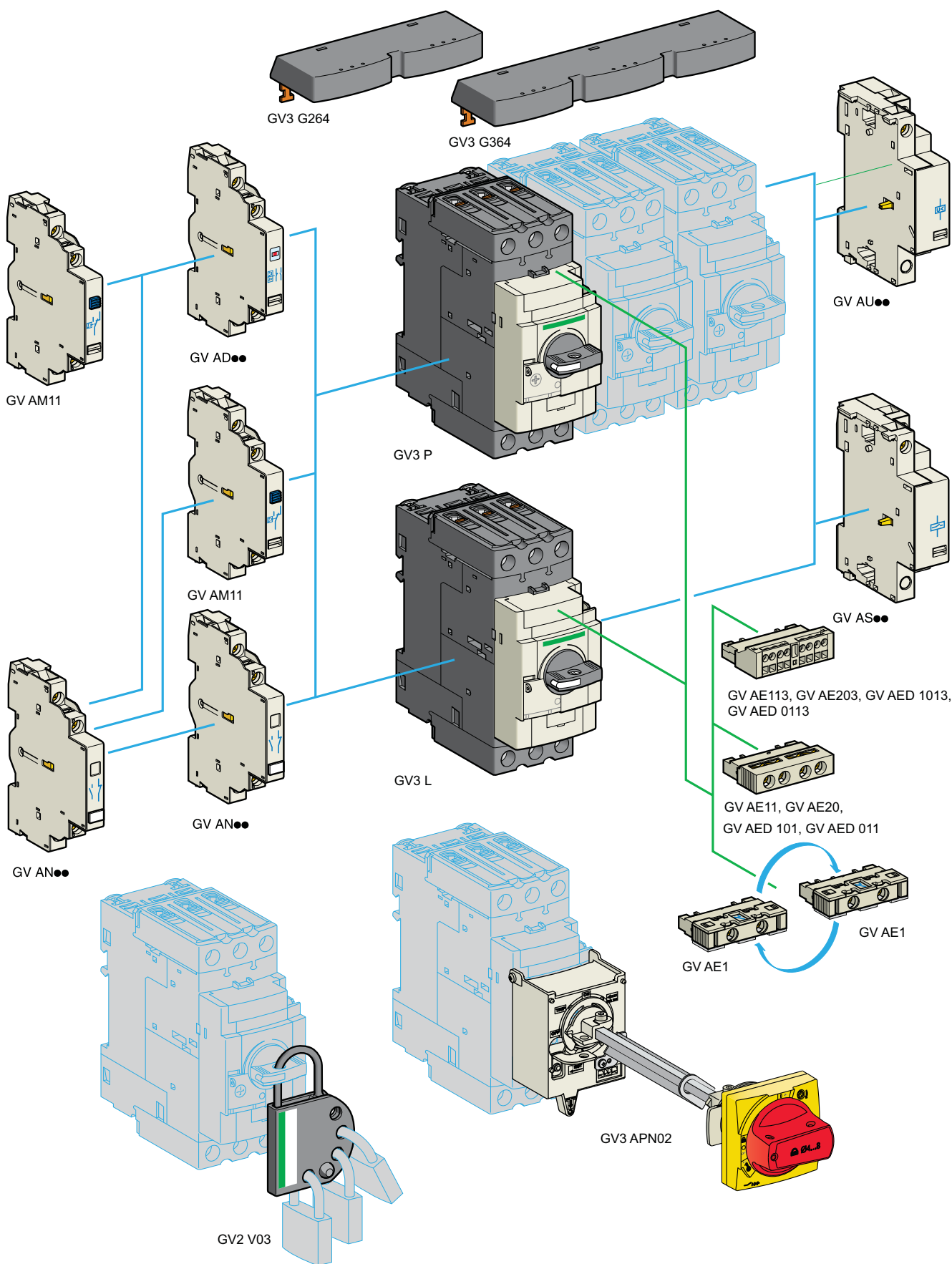

TeSys GV4 Overview

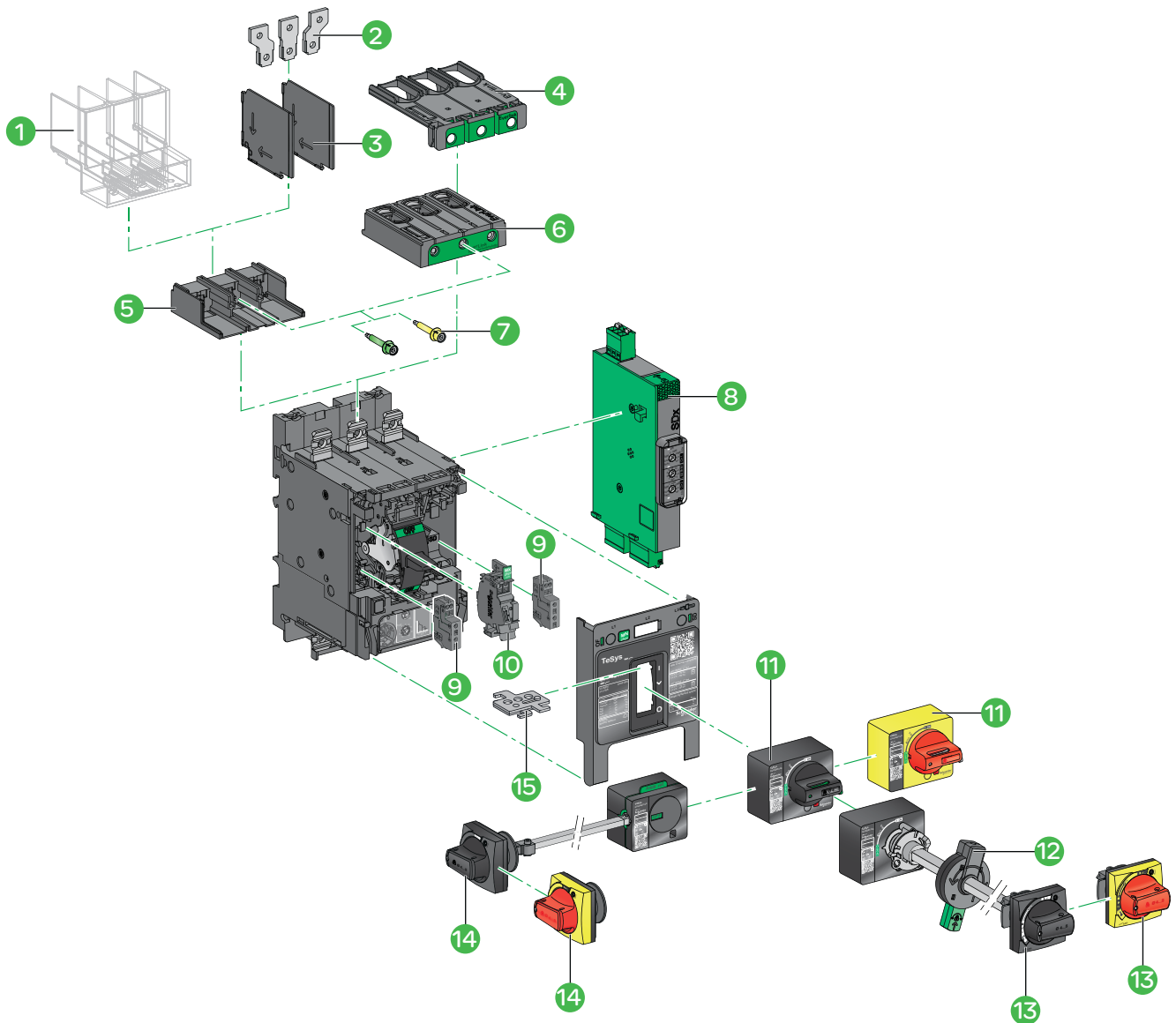

- 1 Long terminal shield LAD96590
- 2 Terminal spreaders LV426940
- 3 Interphases barriers LV426920
- 4 Large spacing cover for EverLink connector GV4G66
- 5 Crimp lug connector GV4LUG
- 6 EverLink® connector LAD96595
- 7 Torque limiting breakaway bits LV42699p
- 8 SDx alarming/fault differentiation module GV4ADM1111 (only with GV4PEM)
- 9 Auxiliary contact block for OF or SD function GV4AE11
- 10 - MN undervoltage release GV4AUpp
- MX shunt trip GV4ASpp
- 11 Direct mounting black or red on yellow bezel rotary handle GV4ADN01/ GV4ADN02
- 12 Open door shaft operator (for front extended rotary handle) LV426937
- 13 Front extended rotary handle kit with red handle on yellow bezel or black handle GV4APN01/
GV4APN02 /GV4APN04
- 14 Side rotary handle kit with red handle on yellow bezel or black handle LV426935/LV426936.
- 15 Toggle locking device 29370

TeSys Control

TeSys Switches

Vario Switch Disconnectors

[Ithe] Conventional Thermal Current**	Poles Description	Rated Operational Power (AC-23)*	Reference	Unit MRP [₹]
Complete Enclosed Switches				
• Range 12 to 175A, IP 65 Sealable and Lockable				
10	3P	4 kW	VCF02GE	3620
16	3P	5.5 kW	VCF01GE	3940
20	3P	7.5 kW	VCF0GE	4790
25	3P	11 kW	VCF1GE	5140
32	3P	15 kW	VCF2GE	6025
50	3P	22 kW	VCF3GE	9315
63	3P	30 kW	VCF4GE	10895

* Rated Power at 415V

** Ith in enclosure

For Switch Type (Amps)	Mounting Arrangement	Ingress	Reference	Unit MRP [₹]
Operators (Padlockable)				
12 - 40	4 Screw Fixing	IP65	KCF1PZ	950
63 - 80	4 Screw Fixing	IP65	KCF2PZ	1005
125 - 175	4 Screw Fixing	IP40	KCF3PZ	4075

Vario Switch Disconnectors

[Ithe] Conventional Thermal Current**	Poles Description	Reference	Unit MRP [₹]
Complete Switch with Padlockable Operator			
• Suitable for Front Mounting or Base Mounting			
12	3P	VCF02	2275
20	3P	VCF01	2475
25	3P	VCF0	2890
32	3P	VCF1	3030
40	3P	VCF2	3750
63	3P	VCF3	6990
80	3P	VCF4	6360
125	3P	VCF5	14575
175	3P	VCF6	17670

Switch Bodies

Reference	Unit MRP [₹]
V02	1480
V01	1710
V0	2035
V1	2475
V2	3030
V3	4215
V4	5540
V5	11245
V6	14350

Accessories

Description	For Use with Switch Bodies	Rating in A	Pole Composition	Earth Contact	Auxiliary Contacts	Reference	Unit MRP [₹]
Vario Add-on Modules ⁽¹⁾							
Main Pole Module	V02/VCF02	12	1P	-	-	VZ02	1060
	V0/1/VCF01	20	1P	-	-	VZ01	1080
	V0/VCF0	25	1P	-	-	VZ0	1150
	V1/VCF1	32	1P	-	-	VZ1	1125
	V2/VCF2	40	1P	-	-	VZ2	1205
	V3/VCF3	63	1P	-	-	VZ3	1565
	V4/VCF4	80	1P	-	-	VZ4	1565
Neutral Pole Module ⁽²⁾	V02 / VCF02 to V2 / VCF2	-	1N	-	-	VZ11	1290
	V3 / VCF3 to V4 / VCF4	-	1N	-	-	VZ12	1730
	V5 / VCZ5 to V6 / VCZ6	-	1N	-	-	VZ13	3570
Earthing Module	V02 / VCF02 to V2 / VCF20	-	-	-	-	VZ14	1275
	V3 / VCF3 to V4 / VCF4	-	-	1	-	VZ15	1505
	V5 / VCZ5 to V6 / VCZ6	-	-	1	-	VZ16	2335
Auxiliary Contact Block Module	V02/ VCF02 to V6 / VCZ6	-	-	-	1NO + 1NC	VZ7	1330
	V2/ VCF02 to V6 / VCZ6	-	-	-	2NO	VZ20	1330

(1) For mounting option of modules, please refer to the technical catalogue.

(2) With early make and late break contacts

Description	For Use With	Reference	Unit MRP [₹]
Components for Door Interlocking			
Shaft extension - for Mini-VARIO and VARIO - V02..V2	V02...V2	VZ17	1275
		VZ30	1505
Shaft extension - for Mini-VARIO and VARIO - V3 V4 V5 V6	V3, V4, V5, V6	VZ18	1710
		VZ31	405
Door interlock plate	VZ17 / VZ30	KZ32	695
		VZ18/31	KZ74
Input Terminal Protection Shrouds			
Terminal Shrouds	V02 - V2	VZ8	430
		VZ26	375
	V3 - V4	VZ9	455
		VZ27	375
	V5 - V6	VZ10	570
		VZ28	635
V02 - V6	VZ29	520	

For details on non standard references, technical parameters, accessories, compatibility, stockable and non stockable status please contact Customer Care

NORMAL STOCK ITEMS

W.E.F. January 25th, 2022

TeSys Control

Accessories for Switches

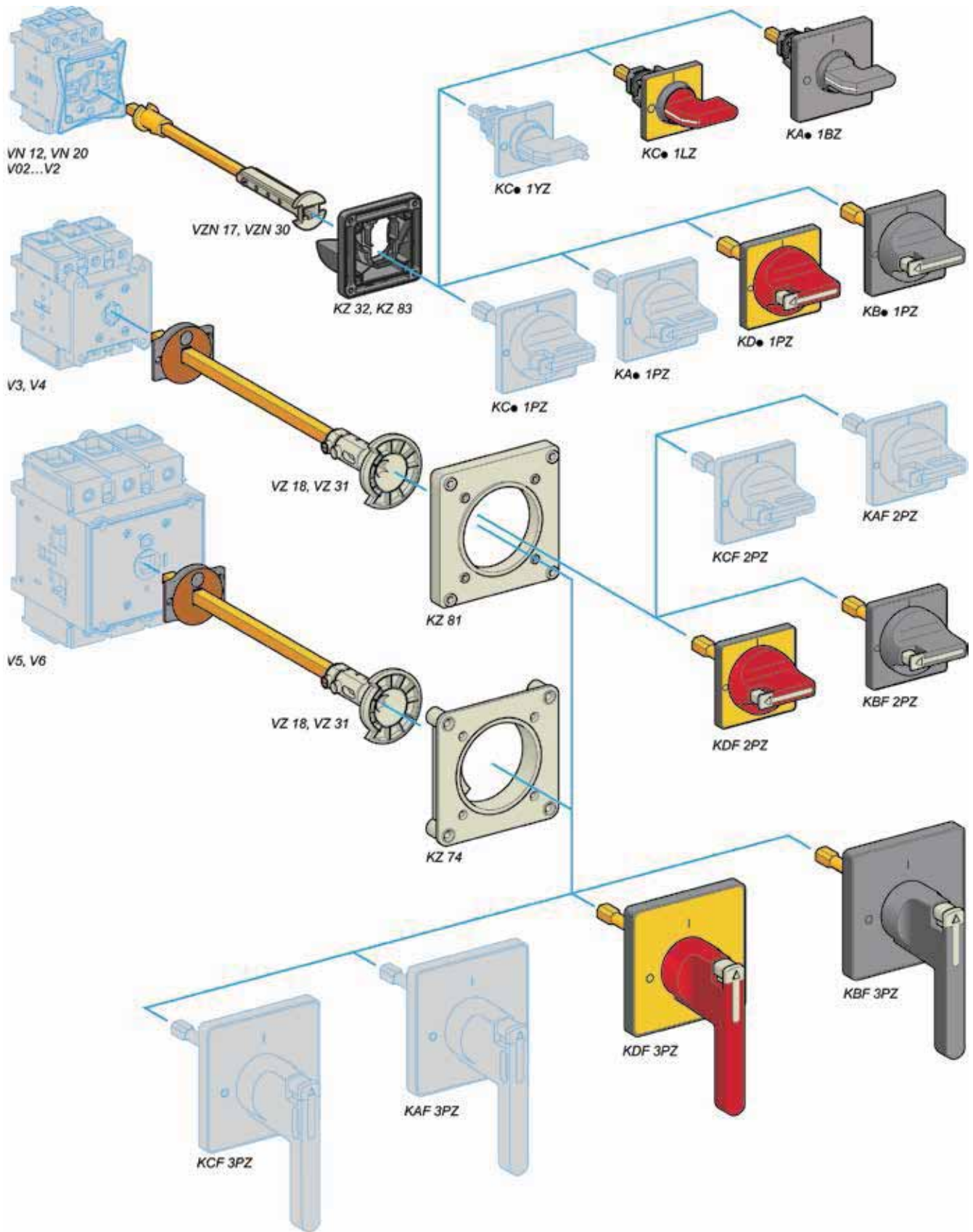



Machine builders, it is time to cut engineering time and costs — DIGITIZE load management

TeSys island

Unique features

TeSys island is a smart, digital multifunctional load management system; it can switch, protect, manage motors and other electrical loads up to 80 Amps (AC3) in an electrical control panel.

Benefits

Why should you choose TeSys island?

- Quicker engineering and reduce time to market
- Embedded algorithms detect abnormal load behaviors and generate alarms before machine stoppage.
- Pre-trip warnings can also be set on the system for scheduled maintenance.
- Fast device replacement on any portion of the island is possible because of the full integration of the system and the integrated Bus coupler resulting in reduced downtime.
- TeSys island provides energy monitoring at the load level
- Health status can be easily accessed, remotely or locally. This energy management data can be used for advanced analytics to increase machine efficiency further
- TeSys island can be easily integrated into Schneider Electric's EcoStruxure Machine architecture and 3rd party automation systems, supporting all major field buses.

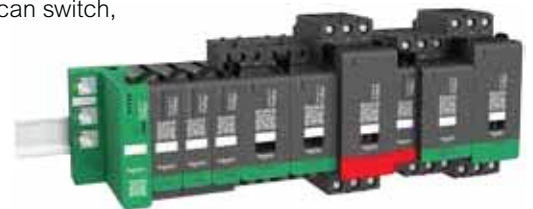

For more information
on TeSys island
Digital Load
Management System

TeSys Active

TeSys island

Enable smarter design and engineering

Efficient

Make your machines intelligent, save time and costs with intuitive programming and commissioning using TeSys avatars. Simplify software integration within all major automation environments. One-click mounting on DIN rail and no need for control wiring.

Enable new business models

Use load data and status information to create new service enabled business models. Access your machine from remote during operation & maintenance.

A data provider

Get relevant data for digital load management & advanced analytics. Monitor energy at load level, remote users can easily check health status, troubleshoot and diagnose issues and take action, reduce machine stoppages and machine downtime.

Improved security

Benefit from the highest cybersecurity and safety levels. Safety IO / Scalable with embedded diagnostic.

Technical specifications

- System consists of DOL Starters & Input / Output modules
- System manages motors and other electrical loads up to 80A/37kW/50hp
- Up to 20 modules / 1 meter at one bus coupler
- No mechanical adjustments/settings required
- International standards-compliant
- Energy monitoring at the load level
- Only 21 commercial references for the complete system, including 5 standard motor starters and 5 functional safety motor starters
- Cybersecurity embedded into the system (Achilles Level 2 & Safety up to Cat 2)
- Safety stop TUV certified (Stop 0 and 1 with wiring categories 1 to 2, suitable for PL c,d (Performance Level) and SIL level 2)
- Open connectivity thanks to Ethernet IP and Modbus TCP fieldbuses

TeSys Active

TeSys island

TeSys island is an innovative digital load management solution-providing data for higher machine efficiency and ease of servicing, and allowing faster time to market.

TeSys island is a modular, multifunctional system providing integrated functions inside an automation architecture, primarily for the direct control and management of low-voltage loads.

After commissioning, TeSys island can switch, help protect, and manage motors and other electrical loads up to 37 kW installed in an electrical control panel.

This system is designed around the concept of TeSys avatars. These avatars:

- Are the functional object representing a logical function of the physical module with pre-defined logic
- Determine the configuration of the island.

The logical aspects of the island are managed with software tools, covering all phases of product and application lifecycle: design, engineering, commissioning, operation, and maintenance.



- | | |
|----------------------------|--------------------------|
| 1 Bus Coupler | 5 Power interface module |
| 2 Analog I/O module | 6 Standard Starter |
| 3 Digital I/O module | 7 SIL Starter |
| 4 Voltage interface module | 8 SIL interface module |

Designation	Product Commercial Reference	
TeSys island components		
Standard Starter	9A (AC-3)	TPRST009
	25A (AC-3)	TPRST025
	38A (AC-3)	TPRST038
	65A (AC-3)	TPRST065
	66A (AC-3) - 80A (AC-1)	TPRST080
SIL Starter	9A (AC-3)	TPRSS009
	25A (AC-3)	TPRSS025
	38A (AC-3)	TPRSS038
	65A (AC-3)	TPRSS065
	66A (AC-3) - 80A (AC-1)	TPRSS080
Power interface module	9A (AC-3)	TPRPM009
	38A (AC-3)	TPRPM038
	80A (AC-3)	TPRPM080
Voltage interface module		TPRVM001
SIL interface module		TPRSM001
Digital I/O module	(4 input - 2 output)	TPRDG4X2
Analog I/O module	(2 input - 1 output)	TPRAN2X1
Bus Coupler	EtherNet/IP - Modbus TCP	TPRBCEIP
	PROFINET	TPRBCPFN
	PROFIBUS	TPRBCPFBS
Assembly and Wiring Kits		
Kit for reversing starter application	for 9, 25, 38A (size 1 and 2) starters	LAD9R1
	for 65, 80A (size 3) starters	LAD9R3
Jumper bar 3-pole for Star Delta application	for 9, 25, 38A (size 1 and 2) starters	LAD9P3
	for 65, 80 A (size 3) starters, a hazard sticker is provided	LAD9SD3S

TeSys Control

Ultra motor starters

Introduction

From traditional solution to ...

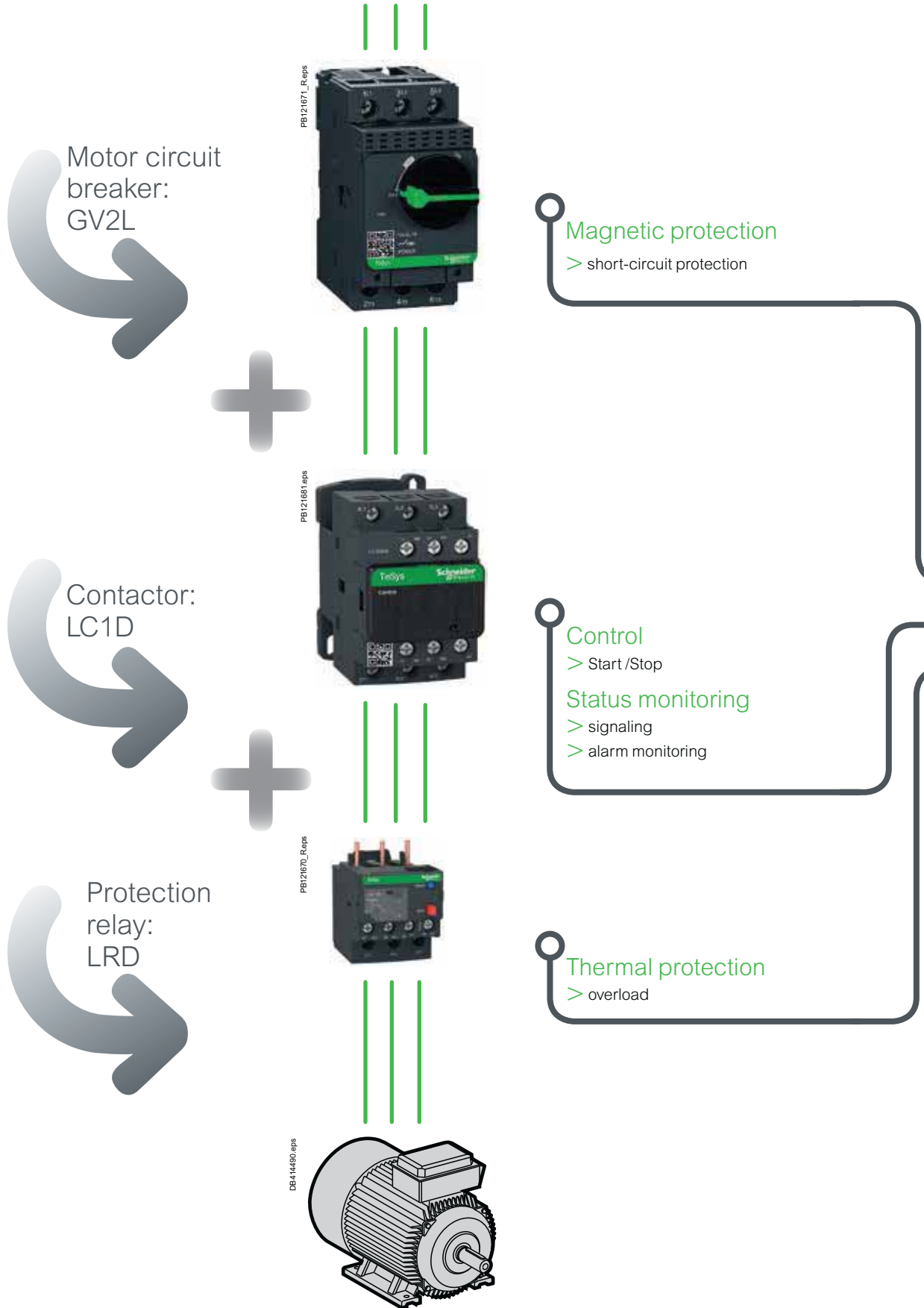

TeSys Control

Ultra motor starters

Introduction

...Ultra motor starter



Ultra motor starter

> All basic or advanced protection and control functions in one block and more...

- > Overload indication and alarm
- > Status report, remote control via communication bus

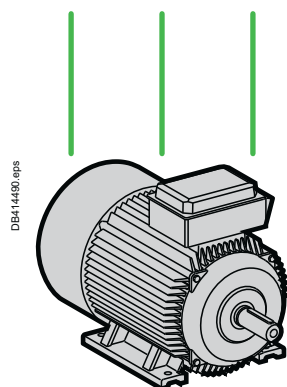

Ultra motor starters can be used in **80 %** of motor protection and control applications.

TeSys Control

Ultra motor starters



- Total Coordinated Starter – 3 functions in a single device
- Compact Starter, DOL / RDOL upto 18.5kW (38A, AC-3) in 45mm width
- Direct connectivity to Modbus / Profibus / CANopen / DeviceNet
- Higher switching life - 15Million operations, 2Million AC-43 electrical life
- Breaking capacity upto 130kA



Power Base

For assembling components, ON/OFF operation and resetting.
 > 3 power bases:
 upto 12A and upto 38A
 > Direct starter and reversing starter models.

Control Unit

Performs all the electrical protection functions to cover main applications from 0 to 38A.

Some of these also provide advanced measurement, alarm and display functions.

4 simple function modules

- Thermal overload alarm Indication of motor load
- Thermal overload signalling and manual reset
- Thermal overloaded signalling and automatic or remote reset.

4 communication modules

- Profibus DP
- CANopen
- DeviceNet
- Modbus.

40%

“TeSys solutions allow us to reduce the size of our enclosure” says a panel builder from the water treatment sector

60%

“Late customization means that we can build 60% of the panels, even though the project design has not yet been completed” says an engineer in a food processing industry

Quick Selection

Select 1	+	Select 1	Optional	or	Optional	or	Optional																																																																																																																																																										
Base Power Unit Non-Reversing <table border="1"> <tr><td>LUB</td><td>120</td></tr> <tr><td>0... 12A with terminal</td><td>12</td></tr> <tr><td>0... 12A no terminal</td><td>120*</td></tr> <tr><td>0... 32A with terminal</td><td>32</td></tr> <tr><td>0... 32A no terminal</td><td>320*</td></tr> <tr><td>0... 38A with terminal</td><td>38</td></tr> <tr><td>0... 38A no terminal</td><td>380*</td></tr> </table> Reversing <table border="1"> <tr><td>LU2B</td><td>120</td><td>BL</td></tr> <tr><td>0... 12A with terminal</td><td>12</td><td></td></tr> <tr><td>0... 12A no terminal</td><td>120*</td><td></td></tr> <tr><td>0... 32A with terminal</td><td>32</td><td></td></tr> <tr><td>0... 32A no terminal</td><td>320*</td><td></td></tr> <tr><td>0... 38A with terminal</td><td>38</td><td></td></tr> <tr><td>0... 38A no terminal</td><td>380*</td><td></td></tr> <tr><td>24 V DC</td><td></td><td>BL</td></tr> <tr><td>24 V AC</td><td></td><td>B</td></tr> <tr><td>48...72 VAC or 48 VDC</td><td></td><td>ES</td></tr> <tr><td>110...240 VAC/DC</td><td></td><td>FU</td></tr> </table> *Prewired cables to be ordered separately	LUB	120	0... 12A with terminal	12	0... 12A no terminal	120*	0... 32A with terminal	32	0... 32A no terminal	320*	0... 38A with terminal	38	0... 38A no terminal	380*	LU2B	120	BL	0... 12A with terminal	12		0... 12A no terminal	120*		0... 32A with terminal	32		0... 32A no terminal	320*		0... 38A with terminal	38		0... 38A no terminal	380*		24 V DC		BL	24 V AC		B	48...72 VAC or 48 VDC		ES	110...240 VAC/DC		FU		Control Unit <table border="1"> <tr><td>LUC</td><td>B</td><td>X6</td><td>BL</td></tr> <tr><td>Class 10, 3Ph</td><td>B</td><td></td><td></td></tr> <tr><td>Class 10, 1Ph</td><td>C</td><td></td><td></td></tr> <tr><td>Class 20, 3Ph</td><td>D</td><td></td><td></td></tr> <tr><td>Multifunction</td><td>M</td><td></td><td></td></tr> <tr><td>0.15 to 0.6 A</td><td></td><td>X6</td><td></td></tr> <tr><td>0.35 to 1.4 A</td><td></td><td>1X</td><td></td></tr> <tr><td>1.25 to 5 A</td><td></td><td>05</td><td></td></tr> <tr><td>3 to 12 A</td><td></td><td>12</td><td></td></tr> <tr><td>4.5 to 18 A</td><td></td><td>18</td><td></td></tr> <tr><td>8 to 38 A</td><td></td><td>38</td><td></td></tr> <tr><td>24V DC</td><td></td><td></td><td>BL</td></tr> <tr><td>24VAC</td><td></td><td></td><td>B</td></tr> <tr><td>48...72 VAC/48 VDC</td><td></td><td></td><td>ES</td></tr> <tr><td>110...240VAC/DC</td><td></td><td></td><td>FU</td></tr> </table>	LUC	B	X6	BL	Class 10, 3Ph	B			Class 10, 1Ph	C			Class 20, 3Ph	D			Multifunction	M			0.15 to 0.6 A		X6		0.35 to 1.4 A		1X		1.25 to 5 A		05		3 to 12 A		12		4.5 to 18 A		18		8 to 38 A		38		24V DC			BL	24VAC			B	48...72 VAC/48 VDC			ES	110...240VAC/DC			FU	Communication Module* <table border="1"> <tr><td>LULC</td><td>033</td></tr> <tr><td>Modbus Serial</td><td>033</td></tr> <tr><td>Profibus DP</td><td>07</td></tr> <tr><td>CANopen</td><td>08</td></tr> <tr><td>DeviceNet</td><td>09</td></tr> </table> Prewired Cables <table border="1"> <tr><th>Description</th><th>Reference</th></tr> <tr><td>Prewired cable for non-reversing power base</td><td>LU9BN11C or LU9BN11L</td></tr> <tr><td>Prewired cable for reversing power base</td><td>LU9MRC or LU9MRL</td></tr> </table>	LULC	033	Modbus Serial	033	Profibus DP	07	CANopen	08	DeviceNet	09	Description	Reference	Prewired cable for non-reversing power base	LU9BN11C or LU9BN11L	Prewired cable for reversing power base	LU9MRC or LU9MRL	Function Module <table border="1"> <tr><td>LUF</td><td>DH11</td></tr> <tr><td>Fault diff. with manual reset</td><td>DH11</td></tr> <tr><td>Fault diff. with auto reset</td><td>DA10</td></tr> <tr><td>Thermal overload pre-alarm</td><td>W10</td></tr> <tr><td>Motor load indication (4-20mA)</td><td>V2</td></tr> </table>	LUF	DH11	Fault diff. with manual reset	DH11	Fault diff. with auto reset	DA10	Thermal overload pre-alarm	W10	Motor load indication (4-20mA)	V2	Auxiliary Contacts Contactor auxiliary contacts <table border="1"> <tr><td>LUFN</td><td>11</td></tr> <tr><td>1NO + 1NC</td><td>11</td></tr> <tr><td>2NC</td><td>02</td></tr> <tr><td>2NO</td><td>20</td></tr> <tr><td>Side contacts 2NO</td><td>LUA8E20</td></tr> </table> Power auxiliary contacts (trip status) <table border="1"> <tr><td>LUA1C</td><td>20</td></tr> <tr><td>1NO + 1NC</td><td>11</td></tr> <tr><td>2NO</td><td>20</td></tr> </table>	LUFN	11	1NO + 1NC	11	2NC	02	2NO	20	Side contacts 2NO	LUA8E20	LUA1C	20	1NO + 1NC	11	2NO	20	Accessories <table border="1"> <tr><th>Description</th><th>Reference</th></tr> <tr><td>Line spacer for UL508 Type E</td><td>LU9SPO</td></tr> <tr><td>Current limiter 130kA@460V</td><td>LUALB1</td></tr> </table>	Description	Reference	Line spacer for UL508 Type E	LU9SPO	Current limiter 130kA@460V	LUALB1
LUB	120																																																																																																																																																																
0... 12A with terminal	12																																																																																																																																																																
0... 12A no terminal	120*																																																																																																																																																																
0... 32A with terminal	32																																																																																																																																																																
0... 32A no terminal	320*																																																																																																																																																																
0... 38A with terminal	38																																																																																																																																																																
0... 38A no terminal	380*																																																																																																																																																																
LU2B	120	BL																																																																																																																																																															
0... 12A with terminal	12																																																																																																																																																																
0... 12A no terminal	120*																																																																																																																																																																
0... 32A with terminal	32																																																																																																																																																																
0... 32A no terminal	320*																																																																																																																																																																
0... 38A with terminal	38																																																																																																																																																																
0... 38A no terminal	380*																																																																																																																																																																
24 V DC		BL																																																																																																																																																															
24 V AC		B																																																																																																																																																															
48...72 VAC or 48 VDC		ES																																																																																																																																																															
110...240 VAC/DC		FU																																																																																																																																																															
LUC	B	X6	BL																																																																																																																																																														
Class 10, 3Ph	B																																																																																																																																																																
Class 10, 1Ph	C																																																																																																																																																																
Class 20, 3Ph	D																																																																																																																																																																
Multifunction	M																																																																																																																																																																
0.15 to 0.6 A		X6																																																																																																																																																															
0.35 to 1.4 A		1X																																																																																																																																																															
1.25 to 5 A		05																																																																																																																																																															
3 to 12 A		12																																																																																																																																																															
4.5 to 18 A		18																																																																																																																																																															
8 to 38 A		38																																																																																																																																																															
24V DC			BL																																																																																																																																																														
24VAC			B																																																																																																																																																														
48...72 VAC/48 VDC			ES																																																																																																																																																														
110...240VAC/DC			FU																																																																																																																																																														
LULC	033																																																																																																																																																																
Modbus Serial	033																																																																																																																																																																
Profibus DP	07																																																																																																																																																																
CANopen	08																																																																																																																																																																
DeviceNet	09																																																																																																																																																																
Description	Reference																																																																																																																																																																
Prewired cable for non-reversing power base	LU9BN11C or LU9BN11L																																																																																																																																																																
Prewired cable for reversing power base	LU9MRC or LU9MRL																																																																																																																																																																
LUF	DH11																																																																																																																																																																
Fault diff. with manual reset	DH11																																																																																																																																																																
Fault diff. with auto reset	DA10																																																																																																																																																																
Thermal overload pre-alarm	W10																																																																																																																																																																
Motor load indication (4-20mA)	V2																																																																																																																																																																
LUFN	11																																																																																																																																																																
1NO + 1NC	11																																																																																																																																																																
2NC	02																																																																																																																																																																
2NO	20																																																																																																																																																																
Side contacts 2NO	LUA8E20																																																																																																																																																																
LUA1C	20																																																																																																																																																																
1NO + 1NC	11																																																																																																																																																																
2NO	20																																																																																																																																																																
Description	Reference																																																																																																																																																																
Line spacer for UL508 Type E	LU9SPO																																																																																																																																																																
Current limiter 130kA@460V	LUALB1																																																																																																																																																																

*Suitable with 24V DC starter variant only

Note: For prices please contact regional sales office or customer care centre

Wherever productivity is a concern, intelligence to Motor Control is the solution



TeSys T Intelligence system optimises the operational performance of LV motors through advanced protections and embedded intelligent functions inside intelligent Motor Control Centre (iMCC)



Discover
TeSys T



Tesys T Motor Management Systems

TeSys T covers all load monitoring and protection needs from feeders to critical process automation. The equipment is protected, while advanced diagnostics, statistics, and alarms help in anticipating unexpected production halts and minimize downtime. TeSys T is compact and a natural fit for control panels with IEC or NEMA standards. In addition, the system's connectivity and access to real-time data provides key information to enhance the operation and safety of the process while improving efficiency.

Tesys T Controller:

Intelligent motor controller for 1P/3P Motors with built in CT up to 100Amps with accurate monitoring and protection functions, 6DI, 4DO, 1CBCT input, 1 Temperature probe

Protection Functions:

- Thermal overload
- Phase imbalance and phase overloads
- Temperature monitoring via probes
- Phase reversal
- Ground fault detection
- Long start and Jam protection
- Load shedding
- Load fluctuations
- power factor monitoring

Monitoring Functions:

- Phase and average current
- Line to Line and average voltage
- Motor temperature, ground current
- Active and Reactive Energy
- Frequency & Power Factor
- Detailed Fault history
- Fault counts
- motor statistics

Control Functions:

- Local / Remote / HMI control
- Predefined programs for DOL, RDOL, Star-delta, two-speed starters

Communication:



Quick Selection

TeSys T Controller

Reference			
	LTM R	100	E BD
Current Range	0.4 - 8 A	08	
	1.35 - 27 A	27	
	5 - 100 A	100	
Network Protocol	CAN Open	C	
	DeviceNet	D	
	Ethernet IP / Modbus TCP/IP	E	
	Modbus	M	
	Profibus DP	P	
Control Voltage	24 V DC	BD	
	110-240V AC	FM	



TeSys T
Full and Flexible
Intelligent Motor
Management System

TeSys T Accessories

TeSys T Expansion Module ^{1,2}		
	Control Voltage	Reference
	24 V DC	LTM EV40BD
	110V AC	LTM EV40FM

¹ Required for Voltage & Power measurement
² 4 digital inputs

Connector for Expansion		
	Length (m)	Reference
	0.04	LTMCC004 ³

³ Sold in lots of 6

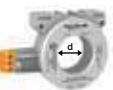
Ground Fault CT's			
	Primary [A]	Internal Ø "d" [mm]	Reference
	65	30	50437
	85	50	50438
	160	80	50439
	250	120	50440
	400	200	50441
	630	300	50442

Description	Composition	Reference
Programming software SoMove	1 Program for each PC	On request
PC connecting cable	USB to RS485 Converter	TCSMCNAM3M002P

Operator Control Display		
	Description	Reference
	Operator Control Display with configuration backup	LTM CUF

Controller to Display Cable		
	Length (m)	Reference
	1.0	LTM9CU10
	3.0	LTM9CU30

Current Transformers ⁴			
	Primary [A]	Secondary [A]	Reference
	100	1	LT6 CT1001
	200	1	LT6 CT2001
	400	1	LT6 CT4001
	800	1	LT6 CT8001

Note: For prices please contact regional sales office or customer care centre

TeSys Control

Enclosed switch-disconnectors and Motor Starters



- Exhaustive Range of industrial starters consisting of DOL, Reversing, Automatic star delta starters upto 400HP
- Better aesthetic & Assured performance
- Test to trip facility
- Built in single phasing protection



>>TDL



>>TSD/A



>>TSD/A

*Please contact local sales office for availability, recommendation and selection

Type 2 Co-ordination chart with TeSys range

Type 2 co-ordination chart for Direct-On-Line starter with circuit breaker and overload protection built into the circuit breaker

Reliable switching for IE2/IE3/IE4 motors



IE2



IE3



IE4

Rated operational voltage, $U_e = 400/415V, 50/60Hz$
Short Circuit Current (I_q) = 50kA

Sr. No.	3 Φ Motor power in kW	Current in A	Circuit Breaker	Setting range of thermal trips (A)	Contactor
1	0.06	0.2	GV2P02 or GV2ME02	0.16...0.25	LC1D09
2	0.09	0.3	GV2P03 or GV2ME03	0.25...0.4	LC1D09
3	0.12	0.44	GV2P04 or GV2ME04	0.4...0.63	LC1D09
4	0.18	0.6	GV2P04 or GV2ME04	0.4...0.63	LC1D09
5	0.25	0.85	GV2P05 or GV2ME05	0.63...1	LC1D09
6	0.37	1.0	GV2P05 or GV2ME05	0.63...1	LC1D09
7	0.55	1.5	GV2P06 or GV2ME06	1...1.6	LC1D09
8	0.75	1.9	GV2P07 or GV2ME07	1.6...2.5	LC1D09
9	1.1	2.7	GV2P08 or GV2ME08	2.5...4	LC1D09
10	1.5	3.6	GV2P08 or GV2ME08	2.5...4	LC1D09
11	2.2	4.9	GV2P10 or GV2ME10	4...6.3	LC1D09
12	3	6.5	GV2P14 or GV2ME14	6...10	LC1D09
13	4	8.5	GV2P14 or GV2ME14	6...10	LC1D09
14	5.5	11.5	GV2P16	9...14	LC1D25
15	7.5	15.5	GV2P20	13...18	LC1D25
16	9	18.1	GV2P21	17...23	LC1D25
17	11	22	GV2P22	20...25	LC1D25
18	15	29	GV2P32	25...40	LC1D32
19	18.5	35	GV3P40	30...40	LC1D50A
20	22	41	GV3P50	37...50	LC1D50A
21	30	55	GV3P65	48...65	LC1D65A
22	37	66	GV4PE/PEM80 ^{*(2)}	62...73	LC1D80
23	45	80	GV4PE/PEM115 ^{*(2)}	65...115	LC1D115
24	55	97	GV4PE/PEM115 ^{*(2)}	65...115	LC1D115
25	75	132	GV5P150 ^{*(2)}	70...150	LC1D150
26	90	160	GV5P220 ^{*(2)}	100...220	LC1G185
27	110	195	GV5P220 ^{*(2)}	100...220	LC1G225
28	132	230	GV6P320 ^{*(2)}	160...320	LC1G265
29	160	280	GV6P320 ^{*(2)}	160...320	LC1G330
30	220	385	GV6P500 ^{*(2)}	250...500	LC1G500
31	250	450	GV6P500 ^{*(2)}	250...500	LC1G500

(1) The breaking performance of circuit-breakers GV2 P can be increased by adding a current limiter GV1 L3

(2) Reference to be completed by replacing the * with the breaking performance code as per table given below:

Circuit breaker type	GV5P150*	GV5P220*	GV5P320*	GV6P500*	GV4PE/PEM80*	GV4PE/PEM115*
Breaking performance I_q (kA) at 400/415V	70	70	70	70	50	50
Breaking performance code	H	H	H	H	N	N

For advanced protection, protection with Electronic Overcurrent Relays, heavy starting, please contact our sales teams.

Type 2 Co-ordination chart

Type 2 co-ordination chart for Direct-On-Line starter with circuit breaker and separate thermal overload relay

Reliable switching for IE2/IE3/IE4 motors



IE2



IE3

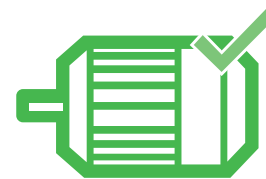

IE4

Rated operational voltage, $U_e = 400/415V, 50/60Hz$
Short Circuit Current (I_q) = 50kA

Sr. No.	3 Φ Motor power in kW	Current in Amps	Circuit Breaker	Contactor	Overload relay	
					Type	Range (A)
1	0.06	0.2	GV2L03 or GV2LE03	LC1D09	LRD02	0.16...0.25
2	0.09	0.3	GV2L03 or GV2LE03	LC1D09	LRD03	0.25...0.40
3	0.12	0.44	GV2L04 or GV2LE04	LC1D09	LRD04	0.4...0.63
4	0.18	0.6	GV2L04 or GV2LE04	LC1D09	LRD04	0.4...0.63
5	0.25	0.85	GV2L05 or GV2LE05	LC1D09	LRD05	0.63...1
6	0.37	1.0	GV2L05 or GV2P06	LC1D09	LRD05	0.63...1
7	0.55	1.5	GV2L06 or GV2LE06	LC1D09	LRD06	1...1.7
8	0.75	1.9	GV2L07 or GV2LE07	LC1D09	LRD07	1.6...2.5
9	1.1	2.7	GV2L08 or GV2LE08	LC1D09	LRD08	2.5...4
10	1.5	3.6	GV2L08 or GV2LE08	LC1D09	LRD08	2.5...4
11	2.2	4.9	GV2L10 or GV2LE10	LC1D09	LRD10	4...6
12	3	6.5	GV2L14 or GV2LE14	LC1D09	LRD12	5.5...8
13	4	8.5	GV2L14 or GV2LE14	LC1D09	LRD14	7...10
14	5.5	11.5	GV2L16	LC1D25	LRD16	9...13
15	7.5	15.5	GV2L20	LC1D25	LRD21	12...18
16	9	18.1	GV2L22	LC1D25	LRD22	16...24
17	11	22	GV2L22	LC1D25	LRD22	16...24
18	15	29	GV3L32	LC1D40A	LRD332	23...32
19	18.5	35	GV3L40	LC1D50A	LRD340	30...40
20	22	41	GV3L50	LC1D50A	LRD350	37...50
21	30	55	GV3L65	LC1D65A	LRD365	48...65
22	37	66	GV4L/LE80 ⁽¹⁾	LC1D80	LRD3363	63...80
23	45	80	GV4L/LE115 ⁽¹⁾	LC1D115	LR9D5367	60...100
24	55	97	GV4L/LE115 ⁽¹⁾	LC1D115	LR9D5369	90...150
25	75	132	NSX160*MA ⁽¹⁾	LC1D150	LR9D5369	90...150
26	90	160	NSX250*MA ⁽¹⁾	LC1G185	LR9G225	57...225
27	110	195	NSX250*MA ⁽¹⁾	LC1G225	LR9G225	57...225
28	132	230	NSX400* + Mic 1.3M ⁽¹⁾	LC1G265	LR9G500	125...500
29	160	280	NSX400* + Mic 1.3M ⁽¹⁾	LC1G330	LR9G500	125...500
30	200	350	NSX630* + Mic 1.3M ⁽¹⁾	LC1G400	LR9G500	125...500
31	220	388	NSX630* + Mic 1.3M ⁽¹⁾	LC1G500	LR9G500	125...500
32	250	430	NSX630* + Mic 1.3M ⁽¹⁾	LC1G500	LR9G500	125...500

(1) Reference to be completed by replacing the * with the breaking performance code as per table given below:

Circuit breaker type	NSX100*MA	NSX160*MA, NSX250*MA	NSX400* NSX630*	GV4L/LE80*	GV4L/LE115*
Breaking performance I_q (kA) at 400/415V	50	50	50	50	50
Breaking performance code	N	N	N	N	N

For advanced protection, protection with Electronic Overcurrent Relays, heavy starting, please contact our sales teams.

Type 2 Co-ordination chart

Type 2 co-ordination chart for Star Delta starters with circuit-breaker and separate thermal overload relay

Reliable switching for IE2/IE3/IE4 motors



IE2



IE3



IE4

Rated operational voltage, $U_e = 400/415V, 50/60Hz$
Short Circuit Current (I_q) = 50kA

Sr. No.	3 Φ Motor power in kW	Line current in Amps	Phase current in Amps	Circuit Breaker	Main/Delta Contactor	Star Contactor	Overload Relay	
							Type	Range (A)
1	5.5	11.5	6.6	GV2L16	LC1D25	LC1D09	LRD12	5.5..8
2	7.5	15.5	8.9	GV2L20	LC1D25	LC1D09	LRD14	7..10
3	9	18.1	10.5	GV2L22	LC1D25	LC1D09	LRD16	9..13
4	11	22	12.7	GV2L22	LC1D25	LC1D09	LRD21	12..18
5	15	29	16.7	GV3L32	LC1D40A	LC1D09	LRD318	12..18
6	18.5	35	20.2	GV3L40	LC1D50A	LC1D09	LRD325	17..25
7	22	41	23.7	GV3L50	LC1D50A	LC1D18	LRD332	23..32
8	30	55	31.8	GV3L65	LC1D65A	LC1D18	LRD340	30..40
9	37	66	38.1	GV3L73	LC1D80A	LC1D32	LRD350	37..50
10	37	66	38.1	GV4L/LE80 ⁽¹⁾	LC1D80A	LC1D32	LRD3357	37..50
11	45	80	46.2	GV4L/LE115 ⁽¹⁾	LC1D115	LC1D65A	LRD3357	37..50
12	55	97	56	GV4L/LE115 ⁽¹⁾	LC1D115	LC1D65A	LRD3359	48..65
13	75	132	76.2	NSX160*MA150 ⁽¹⁾	LC1D150	LC1D65A	LR9D5367	60 ... 100
14	90	160	92.4	NSX250*MA220 ⁽¹⁾	LC1G115	LC1D65	LR9G115	28 ... 115
15	110	195	112.6	NSX250*MA220 ⁽¹⁾	LC1G150	LC1D80	LR9G225	57 ... 225
16	132	230	132.8	NSX400*Mic 1.3M ⁽¹⁾	LC1G150	LC1D80	LR9G225	57 ... 225
17	160	280	161.7	NSX400*Mic 1.3M ⁽¹⁾	LC1G185	LC1D115	LR9G225	57 ... 225
18	200	350	202.1	NSX630*Mic 1.3M ⁽¹⁾	LC1G225	LC1G150	LR9G225	57 ... 225
19	220	388	224	NSX630*Mic 1.3M ⁽¹⁾	LC1G265	LC1G150	LR9G500	125 ... 500
20	250	430	248.3	NSX630*Mic 1.3M ⁽¹⁾	LC1G265	LC1G150	LR9G500	125 ... 500

(1) Reference to be completed by replacing the * with the breaking performance code as per table given below:

Circuit breaker type	NSX100*MA	NSX160*MA, NSX250*MA	NSX400* NSX630*	GV4L/LE80*	GV4L/LE115*
Breaking performance I_q (kA) at 400/415V	50	50	50	50	50
Breaking performance code	N	N	N	N	N

For advanced protection, protection with Electronic Overcurrent Relays, heavy starting, please contact our sales teams.

Type 2 Co-ordination chart

Type 2 co-ordination chart for Star Delta starter with circuit breaker and overload protection built into circuit breaker

Reliable switching for IE2/IE3/IE4 motors



IE2



IE3



IE4

Rated operational voltage, $U_e = 400/415V, 50/60Hz$
Short Circuit Current (I_q) = 50kA / 70kA as per table

Sr. No.	3 Φ Motor power in kW	Line current in Amps	Phase current in Amps	I_q (kA)	Circuit Breaker	Main/Delta Contactor	Star Contactor
1	5,5	11.5	6.6	50	GV2P16	LC1D25	LC1D09
2	7,5	15.5	8.9	50	GV2P20	LC1D25	LC1D09
3	9	18.1	10.5	50	GV2P21	LC1D25	LC1D09
4	11	22	12.7	50	GV2P22	LC1D25	LC1D09
5	15	29	16,7	50	GV3P32	LC1D40A	LC1D09
6	18,5	35	20.2	50	GV3P40	LC1D50A	LC1D09
7	22	41	23.7	50	GV3P50	LC1D50A	LC1D18
8	30	55	31.8	50	GV3P65	LC1D65A	LC1D32
9	37	66	38.1	50	GV3P73	LC1D80A	LC1D32
10	37	66	38.1	70	GV4PE/PEM80 ^{*(1)}	LC1D80A	LC1D32
11	45	80	46.2	70	GV4PE/PEM115 ^{*(1)}	LC1D115	LC1D65A
12	55	97	56.0	70	GV4PE/PEM115 ^{*(1)}	LC1D115	LC1D65A
13	75	132	76.2	70	GV5P150 ^{*(1)}	LC1 D150	LC1D150
14	90	160	92.4	70	GV5P220 ^{*(1)}	LC1 G115	LC1D65
15	110	195	112.6	70	GV5P220 ^{*(1)}	LC1 G150	LC1D80
16	132	230	132.8	70	GV6P320 ^{*(1)}	LC1G150	LC1D95
17	160	280	161.7	70	GV6P320 ^{*(1)}	LC1G185	LC1G115
18	220	388	224.0	70	GV6P500 ^{*(1)}	LC1G265	LC1G150
19	250	430	248.3	70	GV6P500 ^{*(1)}	LC1G265	LC1G150

(1) Reference to be completed by replacing the * with the breaking performance code as per table given below:

Circuit breaker type	GV5P150*	GV5P220*	GV5P320*	GV6P500*	GV4PE/PEM80*	GV4PE/PEM115*
Breaking performance I_q (kA) at 400/415V	70	70	70	70	50	50
Breaking performance code	H	H	H	H	N	N

Type 2 Co-ordination chart

Type 2 Co-ordination chart for Direct-On-Line starter with circuit breaker and separate thermal overload relay

Reliable switching for IE2/IE3/IE4 motors



IE2



IE3



IE4

Sr. No.	3Φ Motor power in kW	Circuit Breaker	Contactor	Thermal Overload Relay
1	0.18	GV4L/LE02*	LC1D09	LRD05
2	0.25	GV4L/LE02*	LC1D09	LRD05
3	0.37	GV4L/LE02*	LC1D09	LRD06
4	0.55	GV4L/LE02*	LC1D09	LRD06
5	0.75	GV4L/LE02*	LC1D09	LRD07
6	1.1	GV4L/LE03*	LC1D25	LRD08
7	1.5	GV4L/LE07*	LC1D32+GV1L3	LRD08
8	2.2	GV4L/LE07*	LC1D32+GV1L3	LRD10
9	3	GV4L/LE07*	LC1D40A	LRD12
10	4	GV4L/LE12*	LC1D65A	LRD14
11	5.5	GV4L/LE12*	LC1D65A	LRD313
12	7.5	GV4L/LE25*	LC1D65A	LRD318
13	10	GV4L/LE25*	LC1D65A	LRD325
14	11	GV4L/LE25*	LC1D65A	LRD325
15	15	GV4L/LE50*	LC1D65A	LRD332
16	18.5	GV4L/LE50*	LC1D65A	LRD340
17	22	GV4L/LE50*	LC1D65A	LRD350
18	30	GV4L/LE80*	LC1D65A	LRD365

* - Reference to be completed by replacing the * with the breaking performance code as per table given below:

Performance I_q (kA) at 415V

Circuit breaker	Breaking performance code		
	B	N	S
GV4L/LE02-12	-	50	100
GV4L/LE25-115	25	50	100

Type 2 Co-ordination chart

Type 2 Co-ordination chart for Star Delta starter with circuit breaker and separate thermal overload relay

Reliable switching for IE2/IE3/IE4 motors



IE2



IE3



IE4

Sr. No.	P (kW)	I _e (A)	I _e /1,73 (A)	Circuit Breaker	Main/Delta Contactor	Star Contactor	Thermal Overload Relay	
1	0.25	0.85	0.5	GV4L/LE02*	LC1D09	LC1D09	LRD05	0.63...1
2	0.37	1	0.6	GV4L/LE02*	LC1D09	LC1D09	LRD06	1...1.7
3	0.55	1.5	0.9	GV4L/LE02*	LC1D09	LC1D09	LRD06	1...1.7
4	0.75	1.9	1.1	GV4L/LE02*	LC1D09	LC1D09	LRD07	1.6...2.5
5	1.1	2.7	1.6	GV4L/LE03*	LC1D25	LC1D09	LRD08	2.5...4
6	1.5	3.6	2.1	GV4L/LE07*	LC1D32+GV1L3	LC1D09	LRD08	2.5...4
7	2.2	4.9	2.8	GV4L/LE07*	LC1D32+GV1L3	LC1D09	LRD10	4...6
8	3	6.5	3.8	GV4L/LE07*	LC1D40A	LC1D09	LRD12	5.5...8
9	4	8.5	4.9	GV4L/LE12*	LC1D65A	LC1D09	LRD14	7...10
10	5.5	11.5	6.6	GV4L/LE12*	LC1D65A	LC1D09	LRD313	9...13
11	7.5	15.5	8.9	GV4L/LE25*	LC1D65A	LC1D09	LRD318	12...18
12	9	18.1	10.5	GV4L/LE25*	LC1D65A	LC1D09	LRD325	16...24
13	11	22	12.7	GV4L/LE25*	LC1D65A	LC1D09	LRD325	16...24
14	15	29	16.7	GV4L/LE50*	LC1D65A	LC1D18	LRD332	23...32
15	18.5	35	20.2	GV4L/LE50*	LC1D65A	LC1D18	LRD340	30...40
16	22	41	23.7	GV4L/LE50*	LC1D65A	LC1D18	LRD350	37...50
17	30	55	31.8	GV4L/LE80*	LC1D65A	LC1D25	LRD365	48...65
18	37	66	38.1	GV4L/LE80*(1)	LC1D80A	LC1D32	LRD3357	37...50

* - Reference to be completed by replacing the * with the breaking performance code as per table given below:

Performance I_q (kA) at 415V

Circuit breaker	Breaking performance code		
	B	N	S
GV4L/LE02-12	-	50	100
GV4L/LE25-115	25	50	100

Type 2 Co-ordination chart with TeSys range (With TeSys G Contactors and Relays) NEW

Type 2 co-ordination chart for Direct-On-Line starter with circuit breaker and overload protection built into the circuit breaker

Reliable
switching for
IE2/IE3/IE4
motors



IE2



IE3



IE4

Rated operational voltage, $U_e = 400/415V, 50/60Hz$
Short Circuit Current (I_q) = 50kA

45 to 250 kW at 400/415V: type 2 coordination (with ref. GV4, GV5, GV6 circuit breakers)							
Sr. No.	Standard power ratings of 3-phase motors 50/60 Hz in category AC-3e			Circuit breaker			Contactor
	400/415V			Reference ⁽¹⁾	I _r Setting	I _{rm}	Reference
	P	I _e	I _q (max)				
	kW	A	kA	A	A		
1	45	80	100	GV4P/GV4PE/GV4PEM115●	86	1118	LC1G115
2	55	97	100	GV4P115●	100	1300	LC1G115
3	55	97	70	GV5P150●	100	1300	LC1G115
4	75	132	70	GV5P150●	140	1820	LC1G150
5	90	160	70	GV5P220●	170	2210	LC1G185
6	110	195	70	GV5P220●	200	2600	LC1G225
7	110	195	70	GV6P320●	200	2600	LC1G265
8	132	230	70	GV6P320●	240	3120	LC1G265
9	160	280	70	GV6P320●	300	3900	LC1G330
10	200	350	70	GV6P500●	380	4940	LC1G400
11	220	380	70	GV6P500●	400	5200	LC1G500
12	250	430	70	GV6P500●	440	5720	LC1G500

(1) Reference to be completed by replacing the ● with the breaking performance code:

Breaking performance I_q (kA)

Code	GV4P/GV4PE/GV4PEM115●			GV5P150●/ 220● GV6P320●/ 500●	
	B	N	S	F	H
400/415V	25	50	100	36	70

Type 2 Co-ordination chart with TeSys range (With TeSys G Contactors and Relays) NEW

Type 2 co-ordination chart for Direct-On-Line starter with circuit breaker and separate relay

Reliable
switching for
IE2/IE3/IE4
motors



IE2



IE3

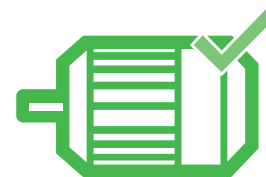

IE4

Rated operational voltage, $U_e = 400/415V, 50/60Hz$
Short Circuit Current (I_q) = 50kA

45 to 335 kW at 400/415V: type 2 coordination (with ref GV4, or NSX circuit breakers)								
Sr. No.	Standard power ratings of 3-phase motors 50/60 Hz in category AC-3e			Circuit breaker		Contactor	Contactor	
	400/415V			Reference ⁽¹⁾	I _{rm}	Reference	Reference	Ir Setting
	P	I _e	I _q (max)					
kW	A	kA		A			A	
1	45	80	100	GV4L/GV4LE115●	1265	LC1G115	LR9G115	80
2	55	97	100	GV4L/GV4LE115●	1100	LC1G115	LR9G225	80
3	45	80	130	NSX100● + MA	1265	LC1G115	LR9G115	97
4	55	97	130	NSX160● + MA	1500	LC1G115	LR9G225	97
5	75	132	130	NSX160● + MA	1800	LC1G150	LR9G225	132
6	90	160	130	NSX250● + MA	2640	LC1G185	LR9G225	160
7	110	195	130	NSX250● + MA	2640	LC1G225	LR9G225	195
8	110	195	130	NSX400● + Micrologic 1.3M	3520	LC1G265	LR9G500	195
9	132	230	130	NSX400● + Micrologic 1.3M	3520	LC1G265	LR9G500	230
10	160	280	130	NSX400● + Micrologic 1.3M	3840	LC1G330	LR9G500	280
11	200	350	130	NSX630● + Micrologic 1.3M	5500	LC1G400	LR9G500	350
12	220	380	130	NSX630● + Micrologic 1.3M	5500	LC1G500	LR9G500	380
13	250	430	130	NSX630● + Micrologic 1.3M	6000	LC1G500	LR9G500	430
14	300	460	130	NS800● + Micrologic 5	8800	LC1G630	LR9G630	460
15	335	575	130	NS800● + Micrologic 5	9600	LC1G630	LR9G630	575

(1) Reference to be completed by replacing the ● with the breaking performance code:

Breaking performance I_q (kA)

Code	GV4L115●/ GV4LE115●			NSX100●/ NSX160●/ NSX250●/ NSX400●/ NSX630●				NS800●		
	B	N	S	F	N	H	R	N	H	L
400/415V	25	50	100	36	50	70	200	50	70	150

Magnetic circuit breakers + Contactor + TeSys T + current transformers

90 to 250 kW at 400/415V: type 2 coordination									
Sr. No.	Standard power ratings of 3-phase motors 50/60 Hz in category AC-3e			Circuit breaker		Contactor	TeSys T Motor management controller	Current transformers	
	400/415V			Reference ⁽¹⁾	Rating I _{rm}	Reference	Reference ⁽²⁾	Ir Setting	Reference
	P	I _e	I _q (max)						
kW	A	kA		A			A		
1	90	160	130	NSX250● + MA	2200	LC1G185	LTMR08●●	160	LT6CT2001
2	110	195	130	NSX250● + MA	2640	LC1G225	LTMR08●●	195	LT6CT2001
3	132	230	130	NSX400● + Micrologic 1.3M	3200	LC1G265	LTMR08●●	230	LT6CT4001
4	150	280	130	NSX400● + Micrologic 1.3M	3840	LC1G330	LTMR08●●	280	LT6CT4001
5	200	350	130	NSX630● + Micrologic 1.3M	5000	LC1G400	LTMR08●●	350	LT6CT4001
6	220	388	130	NSX630● + Micrologic 1.3M	5500	LC1G500	LTMR08●●	388	LT6CT4001
7	250	430	130	NSX630● + Micrologic 1.3M	6000	LC1G500	LTMR08●●	430	LT6CT8001

(1) Reference to be completed by replacing the ● with the breaking performance code:

Breaking performance I_q (kA)

Code	NSX250●/ NSX400●/ NSX630●			
	F	N	H	R
400/415V	36	50	70	200

(2) Please refer to TeSys Catalogue to select the complete reference for TeSys T motor management controller.

Type 2 Co-ordination chart with TeSys range (With TeSys G Contactors and Relays) NEW

Type 2 co-ordination chart for Star Delta starter with circuit breaker and overload protection built into circuit breaker

Reliable switching for IE2/IE3/IE4 motors



IE2



IE3



IE4

Rated operational voltage, $U_e = 400/415V, 50/60Hz$
Short Circuit Current (I_q) = 50kA / 70kA as per table

Contactor: **Maximum operating rate:** 30 starts/hour - **Maximum starting time:** 30 seconds.
The coordination table is for normal starting conditions (Class 10e/ 20e). For other heavy starting applications with long start times, please contact technical support.
RE17RMMWS timer to be used for Star-Delta starter application.

90 to 250 kW at 400/415V: type 2 coordination								
Sr. No.	Standard power ratings of 3-phase motors 50/60 Hz in category AC-3			Circuit breaker			Contactor Line/ Delta	Contactor Star
	400/415V			Reference ⁽¹⁾	Ir Setting	Irm	Reference	
	P kW	Ie A	Iq (max) kA					
1	90	160	70	GV5P220●	170	1360	LC1G115	LC1D65
2	110	195	70	GV5P220●	200	1600	LC1G150	LC1D80
3	110	195	70	GV6P320●	200	1600	LC1G150	LC1D80
4	132	230	70	GV6P320●	240	1920	LC1G150	LC1D95
5	160	280	70	GV6P320●	300	2400	LC1G185	LC1G115
6	200	350	70	GV6P500●	380	3040	LC1G225	LC1G115
7	220	380	70	GV6P500●	400	3200	LC1G265	LC1G150
8	250	430	70	GV6P500●	440	3520	LC1G265	LC1G150

(1) Reference to be completed by replacing the ● with the breaking performance code:

Breaking performance Iq (kA)

Code	GV5P220● GV6P320●/GV6P500●	
	F	H
400/415V	36	70

90 to 450 kW at 400/415V: type 2 coordination								
Sr. No.	Standard power ratings of 3-phase motors 50/60 Hz in category AC-3			Circuit breaker			Contactor Line/ Delta	Contactor Star
	400/415V			Reference ⁽¹⁾	Ir Setting	Irm	Reference	
	P kW	Ie A	Iq (max) kA					
1	90	160	130	NSX250● + Micrologic 2.2M	170	1360	LC1G115	LC1D65
2	110	195	130	NSX250● + Micrologic 2.2M	200	1600	LC1G150	LC1D80
3	110	195	130	NSX400● + Micrologic 2.3M	200	1600	LC1G150	LC1D80
4	132	230	130	NSX400● + Micrologic 2.3M	240	1920	LC1G150	LC1D95
5	160	280	130	NSX400● + Micrologic 2.3M	300	2400	LC1G185	LC1G115
6	200	350	130	NSX630● + Micrologic 2.3M	380	3040	LC1G225	LC1G115
7	220	380	130	NSX630● + Micrologic 2.3M	400	3200	LC1G265	LC1G150
8	250	430	130	NSX630● + Micrologic 2.3M	440	3520	LC1G265	LC1G150
9	300	460	130	NS800● + Micrologic 5	480	3840	LC1G330	LC1G185
10	335	575	130	NS800● + Micrologic 5	640	5120	LC1G400	LC1G225
11	355	610	130	NS800● + Micrologic 5	640	5120	LC1G400	LC1G225
12	400	690	130	NS800● + Micrologic 5	720	5760	LC1G500	LC1G265
13	450	770	130	NS1000● + Micrologic 5	784	6272	LC1G500	LC1G330

(1) Reference to be completed by replacing the ● with the breaking performance code:

Breaking performance Iq (kA)

Code	NSX250●/ NSX400●/ NSX630●				NS800●/ NS1000●		
	F	N	H	R	N	H	L
400/415V	36	50	70	200	50	70	150

Type 2 Co-ordination chart with TeSys range (With TeSys G Contactors and Relays) NEW

Type 2 Co-ordination chart for Direct-On-Line starter with circuit breaker and separate thermal overload relay

Reliable switching for IE2/IE3/IE4 motors



IE2



IE3



IE4

Contactor: **Maximum operating rate:** 30 starts/hour - **Maximum starting time:** 30 seconds.

The coordination table is for normal starting conditions (Class 10e/ 20e). For other heavy starting applications with long start times, please contact technical support.

RE17RMMWS timer to be used for Star-Delta starter application.

90 to 450 kW at 400/415V: type 2 coordination

Sr. No.	Standard power ratings of 3-phase motors 50/60 Hz in category AC-3			Circuit breaker		Contactor Line/ Delta	Contactor Star	Thermal overload relay	
	400/415V			Reference ⁽¹⁾	I _{rm}	Reference		Reference	Setting range
	P	I _e	I _q (max)						
	kW	A	kA	A	A				
1	90	160	130	NSX250● + MA	1980	LC1G115	LC1D65	LR9G115	92
2	110	195	130	NSX250● + MA	1980	LC1G150	LC1D80	LR9G225	113
3	110	195	130	NSX400● + Micrologic 1.3M	1920	LC1G150	LC1D80	LR9G225	113
4	132	230	130	NSX400● + Micrologic 1.3M	1920	LC1G150	LC1D80	LR9G225	133
5	160	280	130	NSX400● + Micrologic 1.3M	2560	LC1G185	LC1G115	LR9G225	162
6	200	350	130	NSX630● + Micrologic 1.3M	3000	LC1G225	LC1G150	LR9G225	202
7	220	380	130	NSX630● + Micrologic 1.3M	3500	LC1G265	LC1G150	LR9G500	219
8	250	430	130	NSX630● + Micrologic 1.3M	3500	LC1G265	LC1G150	LR9G500	248
9	300	460	130	NS800● + Micrologic 5	4000	LC1G330	LC1G185	LR9G500	266
10	335	575	130	NS800● + Micrologic 5	4800	LC1G400	LC1G225	LR9G500	332
11	355	610	130	NS800● + Micrologic 5	5600	LC1G400	LC1G225	LR9G500	352
12	400	627	130	NS800● + Micrologic 5	5600	LC1G400	LC1G225	LR9G500	362
13	450	695	130	NS800● + Micrologic 5	6400	LC1G500	LC1G265	LR9G500	401

(1) Reference to be completed by replacing the ● with the breaking performance code:

Breaking performance I_q (kA)

Code	NSX250●/ NSX400●/ NSX630●				NS800●		
	F	N	H	R	N	H	L
400/415V	36	50	70	200	50	70	150

TeSys Giga series - Device selection

Coordination tables

Star-Delta motor starter - Common circuit diagrams

Star-Delta motor 'Power' circuit diagram

Thermal magnetic circuit breaker + contactors

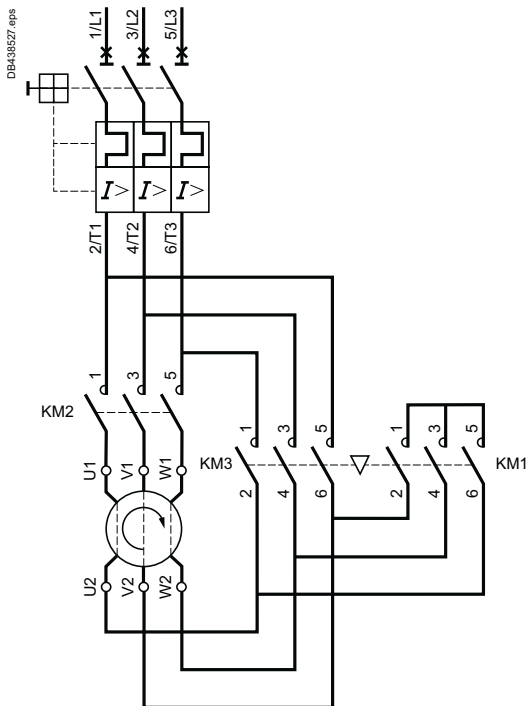

Magnetic circuit breaker + contactors + overload relay

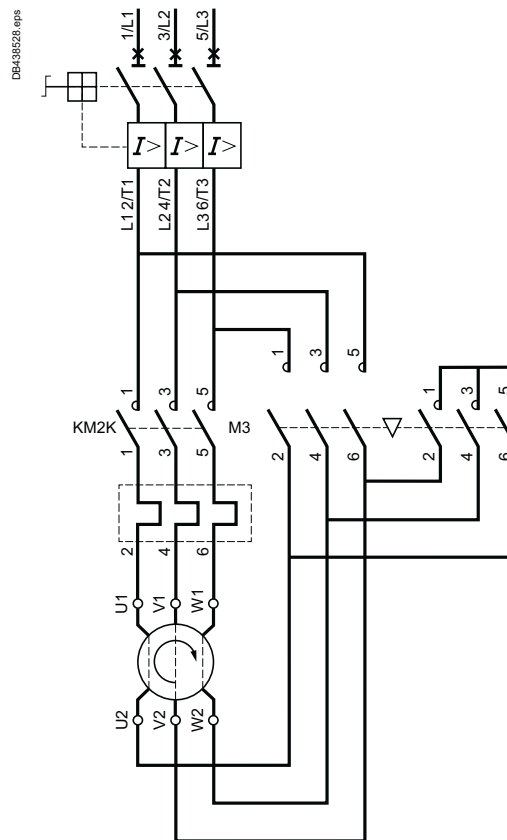

Star-Delta Motor 'Control' circuit diagram

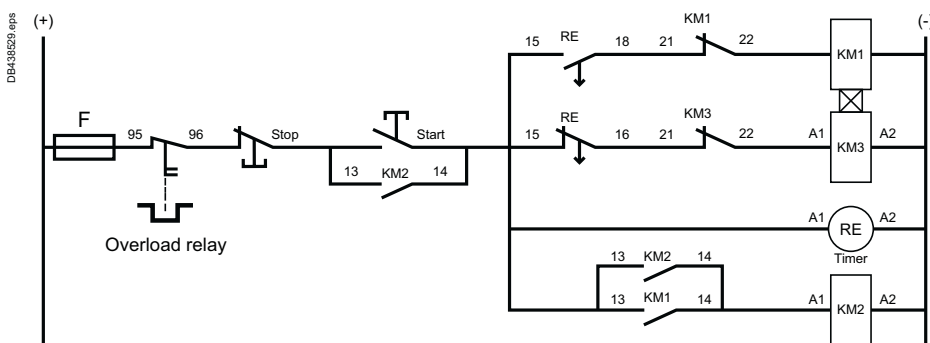

Recommended timing relay (RE): Zelio Time ref. RE17RMMW (12...240 V AC/DC 50/60 Hz – 8 A AC/DC contacts)

Type 2 Recommended Selection Charts for Motor Feeder with EasyPact

Notes:

- Selection is for Normal Starting time (Relay Trip classes 10A/10) applications.
- Overload relay type LRE and EOCR both can be used. However, while using EOCR, setting of Trip class in EOCR should be up to 10/10A only.
- For high Inertia loads like Blowers, Pumps & ID/FD fans etc., if taking longer starting time, kindly consult us to derive the selection. However, this selection can still be used if these applications accept relay trip class 10A/10.
- Service factor of the motors considered is 1
- Selection is directly valid for Switching & Protection of Motors which comply to IS: 12615 efficiency class and can also be used for other non-standard motors whose starting current is less than or equal to starting currents as described in IS: 12615
- The rated motor current used for derivation is Full Load Current (FLC) for 3-phase, 4 Pole Squirrel Cage Induction Motors as indicated in IS: 12615. Selection can also be used for 2 Pole, 6 Pole and 8 Pole Motors based on rated motor current.
- Higher ratings of Contactors can be used in place of recommended combinations.
- These charts are derived basis Type-2 Methodology described in IEC 60947-4, Clause B.4.5.
- For Star-Delta Motor feeders, In-side delta wiring is considered.
- For Star Delta Motor feeders, proper Change-over time and Pause time must be ensured. Selected combination of Motor feeders components in this chart are valid only and only when used along with timer MSMI06 and equivalent timer from Schneider.
- This selection is valid only for suggested Product combinations. Change in any of the recommended combination including timer will invalidate the recommendations and Human safety, Installation safety and product safety requirements may not be fulfilled.
- In case of motor feeders with Circuit breaker, ensure proper Instantaneous setting as suggested in respective charts, if any.
- Max. Operating rate per Hour for contactors & Circuit breaker for Motor protection shall not be exceeded.
- Product evolution and improvement is a Continuous process at Schneider Electric. Hence, recommendations and guidelines are subject to change. Contact Schneider Electric for latest guidelines.

Contact our nearest sales office for application specific Custom / optimised selection for your motor feeders having motors with service factor more than 1, longer starting time applications, Closed transition star delta starters, other than 400/415V perational voltages, starting currents / inrush currents lower than specified in IS 12615

Selection Chart

Direct-on-Line starters with circuit-breaker and overload protection built into the circuit-breaker
Type GZ1E

Reliable
switching for
IE2/IE3 motors



IE2



IE3

Rated Operational Voltage, $U_e = 400/415V, 50/60Hz$
Short Circuit Current $I_q = 50kA$

Type-2 Recommended Selection

Sr. No.	3Φ Motors			I _q Current (kA)	Contactor	Overload Relay		Circuit Breaker	
	kW	HP	FLC - I _n (Amps)			Type	Range (A)	Type	Rating (A)
1	0.06	x	0.19	50	LC1E09	In-built in Circuit Breaker		GZ1E02	0.16 - 0.25
2	0.09	x	0.28	50	LC1E09			GZ1E03	0.25 - 0.4
3	0.12	0.16	0.51	50	LC1E09			GZ1E04	0.4 - 0.63
4	0.18	0.25	0.6	50	LC1E09			GZ1E04	0.4 - 0.63
5	0.25	0.33	0.8	50	LC1E09			GZ1E05	0.63 - 1
6	0.37	0.5	1.4	50	LC1E09			GZ1E06	1 - 1.6
7	0.55	0.75	1.7	50	LC1E09			GZ1E07	1.6 - 2.5
8	0.75	1	2.2	50	LC1E09			GZ1E07	1.6 - 2.5
9	1.1	1.5	2.9	50	LC1E09			GZ1E08	2.5 - 4
10	1.3	1.75	3	50	LC1E09			GZ1E08	2.5 - 4
11	1.5	2	3.8	50	LC1E09			GZ1E08	2.5 - 4
12	2.2	3	5.1	50	LC1E18			GZ1E10	4 - 6.3
13	3	4	6	50	LC1E18			GZ1E14	6 - 10
14	3.7	5	8.1	50	LC1E25			GZ1E14	6 - 10
15	4	5.5	8.5	50	LC1E25			GZ1E14	6 - 10
16	5.5	7.5	11.4	50*	LC1E32			GZ1E16	9 - 14
17	7.5	10	15.4	50*	LC1E32			GZ1E20	13 - 18
18	9.3	12.5	17.3	50*	LC1E40B			GZ1E21	17 - 23
19	11	15	22	50*	LC1E40B			GZ1E22	20 - 25
20	13	17.5	24	50*	LC1E50			GZ1E32	24 - 32
21	15	20	30	50*	LC1E50			GZ1E32	24 - 32

* 50kA With current Limiter type GV1L3, 10kA without current limiter

Selection Chart

Direct-On-Line starters with circuit-breaker GZL1LE and separate thermal overload relay

Reliable
switching for
IE2/IE3 motors



IE2



IE3

Rated Operational Voltage, $U_e = 400/415V, 50/60Hz$
Short Circuit Current $I_q = 50kA$ upto 4kw and above 4kw with 50kA
With current Limiter type GV1L3, 10kA without current limiter

Type-2 Recommended Selection

Sr. No.	P (kW)	I_e (A)	Circuit Breaker	Contactor	Thermal Overload relay	Range (A)
1	0.09	0.4	GZ1LE03	LC1E09	LRE03	0.25...0.40
2	0.18	0.63	GZ1LE04	LC1E09	LRE04	0.4...0.63
3	0.25	1	GZ1LE05	LC1E09	LRE05	0.63...1
4	0.37	1.4	GZ1LE06	LC1E09	LRE06	1...1.6
5	0.75	2.2	GZ1LE07	LC1E09	LRE07	1.6...2.5
6	1.5	3.8	GZ1LE08	LC1E09	LRE08	2.5...4
7	2.2	5.1	GZ1LE10	LC1E18	LRE10	4...6
8	4	8.5	GZ1LE14	LC1E25	LRE14	7...10
9	5.5	11.4	GZ1LE16	LC1E32	LRE16	9...13
10	7.5	15.4	GZ1LE20	LC1E32	LRE21	12...18
11	9.3	17.3	GZ1LE22	LC1E40	LRE22	16...24
12	11	22	GZ1LE22	LC1E40	LRE22	16...24
13	15	30	GZ1LE32	LC1E50	LRE32	23...32

Star Delta starters with circuit-breaker GZL1LE and separate thermal overload relay

Type-2 Recommended Selection

Sr. No.	P (kW)	I_e (A)	$I_e/1,73$ (A)	Circuit Breaker	Main/Delta Contactor	Star Contactor	Thermal Overload Relay	
1	0.09	0.4	0.2	GZ1LE03	LC1E09	LC1E09	LRE02	0.16...0.25
2	0.18	0.63	0.4	GZ1LE04	LC1E09	LC1E09	LRE03	0.25...0.40
3	0.25	1	0.6	GZ1LE05	LC1E09	LC1E09	LRE04	0.4...0.63
4	0.37	1.4	0.8	GZ1LE06	LC1E09	LC1E09	LRE05	0.63...1
5	0.75	2.2	1.3	GZ1LE07	LC1E09	LC1E09	LRE06	1...1.6
6	1.5	3.8	2.2	GZ1LE08	LC1E09	LC1E09	LRE07	1.6...2.5
7	2.2	5.1	2.9	GZ1LE10	LC1E18	LC1E09	LRE08	2.5...4
8	4	8.5	4.9	GZ1LE14	LC1E25	LC1E09	LRE10	4...6
9	5.5	11.4	6.6	GZ1LE16	LC1E32	LC1E09	LRE12	5.5...8
10	7.5	15.4	8.9	GZ1LE20	LC1E32	LC1E09	LRE14	7...10
11	9.3	17.3	10.0	GZ1LE22	LC1E40B	LC1E18	LRE16	9...13
12	11	22	12.7	GZ1LE22	LC1E40B	LC1E18	LRE16	9...13
13	15	30	17.3	GZ1LE32	LC1E50	LC1E18	LRE21	12...18

Selection Chart

Direct-on-Line starters with Fuses and overload protection by separate overload relay type LRE (thermal) or EOCR** (up to Trip class 10/10A)

Reliable
switching for
IE2 motors



IE2

Rated Operational Voltage, $U_e = 400/415V, 50/60Hz$
Short Circuit Current $I_q = 50kA$

Type-2 Recommended Selection

Sr. No.	3Φ Motors			Contactor	Overload Relay		Nominal Back-up Fuse			SDF
	kW	HP	FLC - I_n (Amps)		Type	Range (A)	Fuse	Fuse Rating	Fuse Size	
1	0.12	0.16	0.51	LC1E09	LRE04	0.4-0.63	4NHG000B	4	000	NX032
2	0.18	0.25	0.6	LC1E09	LRE04	0.4-0.63	4NHG000B	4	000	NX032
3	0.25	0.33	0.8	LC1E09	LRE05	0.63-1	4NHG000B	4	000	NX032
4	0.37	0.5	1.4	LC1E09	LRE06	1-1.6	4NHG000B	4	000	NX032
5	0.55	0.75	1.7	LC1E09	LRE06	1-1.6	4NHG000B	4	000	NX032
6	0.75	1	2.2	LC1E09	LRE07	1.6-2.5	6NHG000B	6	000	NX032
7	1.1	1.5	2.9	LC1E09	LRE08	2.5-4	10NHG000B	10	000	NX032
8	1.3	1.75	3	LC1E09	LRE08	2.5-4	10NHG000B	10	000	NX032
9	1.5	2	3.8	LC1E09	LRE08	2.5-4	10NHG000B	10	000	NX032
10	2.2	3	5.1	LC1E09	LRE10	4-6	16NHG000B	16	000	NX032
11	3	4	6	LC1E09	LRE12	5.5-8	20NHG000B	20	000	NX032
12	3.7	5	8.1	LC1E09	LRE14	7-10	20NHG000B	20	000	NX032
13	4	5.5	8.5	LC1E09	LRE14	7-10	20NHG000B	20	000	NX032
14	5.5	7.5	11.4	LC1E12	LRE16	9-13	25NHG000B	25	000	NX032
15	7.5	10	15.4	LC1E18	LRE21	12-18	32NHG000B	32	000	NX063
16	9.3	12.5	17.3	LC1E25	LRE22	16-24	50NHG000B	50	000	NX063
17	11	15	22	LC1E25	LRE22	16-24	50NHG000B	50	000	NX063
18	13	17.5	24	LC1E32	LRE32	23-32	50NHG000B	50	000	NX063
19	15	20	30	LC1E32	LRE32	23-32	63NHG000B	63	000	NX063
20	18.5	25	36	LC1E40	LRE355	30-40	80NHG000B	80	000	NX080
21	22	30	43	LC1E50	LRE357	37-50	80NHG000B	80	000	NX080
22	30	40	56	LC1E65	LRE359	48-65	100NHG000B	100	000	NX100
23	37	50	69	LC1E80	LRE363	63-80	125NHG000B	125	00	NX125
24	45	60	84	LC1E95	LRE365	80-104	160NHG000B	160	00	NX160
25	55	75	99	LC1E120	LRE482	84-135	160NHG000B	160	00	NX160
26	75	100	134	LC1E160	LRE483*	124-198	250NHG1B	250	1	NX250
27	80	110	139	LC1E160	LRE483*	124-198	250NHG1B	250	1	NX250
28	90	120	164	LC1E200	LRE483	124-198	250NHG1B	250	1	NX250
29	110	150	204	LC1E250	LRE484	146-234	250NHG1B	250	1	NX250
30	125	170	234	LC1E250	LRE485	174-279	315NHG2B	315	2	NX315
31	132	180	247	LC1E250	LRE485	174-279	315NHG2B	315	2	NX315
32	160	215	288	LC1E300	LRE486	208-333	400NHG2B	400	2	NX400
33	180	240	298	LC1E300	LRE486	208-333	400NHG2B	400	2	NX400
34	200	270	348	LC1E400	LRE487	258-414	400NHG2B	400	2	NX400
35	225	300	360	LC1E400	LRE487	258-414	500NHG3B	500	3	NX630
36	250	335	435	LC1E500	LRE488	321-513	630NHG3B	630	3	NX630
37	275	370	440	LC1E500	LRE488	321-513	630NHG3B	630	3	NX630
38	315	425	548	LC1E630	LRE489	394-630	800NHG3B	800	3	NA
39	335	452	580	LC1E630	LRE489	394-630	800NHG3B	800	3	NA

* Relay can match with contactor electrically (i.e Cannot be directly mounted), rest all relays are suitable for direct mounting as per catalogue.

** Selection valid upto Trip class 10/10A, Contact nearest sales office for details of EOCR to be used with this selection charts.

Selection Chart

Star Delta starters with Fuses and overload protection by separate overload relay type LRE (thermal) or EOCR** (up to Trip class 10/10A)

Reliable switching for IE2 motors



IE2

Rated Operational Voltage, $U_e = 400/415V, 50/60Hz$
Short Circuit Current $I_q = 50kA$

Type-2 Recommended Selection

Sr. No.	3Φ Motors				Contactor			Overload Relay		Nominal Back-up Fuse			SDF	Minimum Pause time (mSec)	Star-Delta Timer#
	kW	HP	FLC - I_n (Amps)		Main	Delta	Star	Type	Range (A)	Fuse type	Fuse Rating	Fuse Size			
			Line	Phase											
1	0.75	1	2.2	1.3	LC1E09	LC1E09	LC1E09	LRE06	1-1.6	4NHG000B	4	000	NX032	50	MSMI06
2	1.1	1.5	2.9	1.7	LC1E09	LC1E09	LC1E09	LRE07	1.6-2.5	4NHG000B	4	000	NX032	50	MSMI06
3	1.3	1.75	3	1.7	LC1E09	LC1E09	LC1E09	LRE07	1.6-2.5	4NHG000B	4	000	NX032	50	MSMI06
4	1.5	2	3.8	2.2	LC1E09	LC1E09	LC1E09	LRE07	1.6-2.5	6NHG000B	6	000	NX032	50	MSMI06
5	2.2	3	5.1	2.9	LC1E09	LC1E09	LC1E09	LRE08	2.5-4	10NHG000B	10	000	NX032	50	MSMI06
6	3	4	6	3.5	LC1E09	LC1E09	LC1E09	LRE08	2.5-4	10NHG000B	10	000	NX032	50	MSMI06
7	3.7	5	8.1	4.7	LC1E09	LC1E09	LC1E09	LRE10	4-6	10NHG000B	10	000	NX032	50	MSMI06
8	4	5.5	8.5	4.9	LC1E09	LC1E09	LC1E09	LRE10	4-6	16NHG000B	16	000	NX032	50	MSMI06
9	5.5	7.5	11.4	6.6	LC1E09	LC1E09	LC1E09	LRE12	5.5-8	16NHG000B	16	000	NX032	50	MSMI06
10	7.5	10	15.4	8.9	LC1E09	LC1E09	LC1E09	LRE14	7-10	20NHG000B	20	000	NX032	50	MSMI06
11	9.3	12.5	17.3	10.0	LC1E12	LC1E12	LC1E09	LRE14	7-10	20NHG000B	20	000	NX032	50	MSMI06
12	11	15	22	12.7	LC1E18	LC1E18	LC1E09	LRE16	9-13	32NHG000B	32	000	NX032	50	MSMI06
13	15	20	30	17.3	LC1E18	LC1E18	LC1E09	LRE21	12-18	40NHG000B	40	000	NX063	50	MSMI06
14	18.5	25	36	20.8	LC1E25	LC1E25	LC1E09	LRE22	16-24	40NHG000B	40	000	NX063	50	MSMI06
15	22	30	43	24.8	LC1E25	LC1E25	LC1E25	LRE32	23-32	50NHG000B	50	000	NX063	50	MSMI06
16	30	40	56	32.3	LC1E40	LC1E40	LC1E25	LRE355	30-40	63NHG000B	63	000	NX063	50	MSMI06
17	37	50	69	39.8	LC1E50	LC1E50	LC1E32	LRE355	30-40	80NHG000B	80	000	NX080	50	MSMI06
18	45	60	84	48.5	LC1E50	LC1E50	LC1E32	LRE357	37-50	100NHG000B	100	00	NX125	50	MSMI06
19	55	75	99	57.2	LC1E65	LC1E65	LC1E40	LRE359	48-65	125NHG000B	125	00	NX125	50	MSMI06
20	75	100	134	77.4	LC1E80	LC1E80	LC1E65	LRE363	63-80	160NHG000B	160	00	NX160	50	MSMI06
21	80	110	139	80.3	LC1E80	LC1E80	LC1E80	LRE363	63-80	160NHG000B	160	00	NX160	50	MSMI06
22	90	120	164	94.7	LC1E95	LC1E95	LC1E80	LRE365	80-104	200NHG1B	200	1	NX200	50	MSMI06
23	110	150	204	117.8	LC1E120	LC1E120	LC1E95	LRE482	84-135	250NHG1B	250	1	NX250	50	MSMI06
24	125	170	234	135.1	LC1E160	LC1E160	LC1E120	LRE483*	124-198	250NHG1B	250	1	NX250	50	MSMI06
25	132	180	247	142.6	LC1E160	LC1E160	LC1E120	LRE483*	124-198	250NHG1B	250	1	NX250	50	MSMI06
26	150	200	248	143.2	LC1E160	LC1E160	LC1E120	LRE483*	124-198	250NHG1B	250	1	NX250	50	MSMI06
27	160	215	288	166.3	LC1E200	LC1E200	LC1E160	LRE483	124-198	315NHG2B	300	2	NX315	50	MSMI06
28	180	240	298	172.1	LC1E200	LC1E200	LC1E160	LRE483	124-198	315NHG2B	300	2	NX315	50	MSMI06
29	200	270	348	200.9	LC1E250	LC1E250	LC1E160	LRE484	146-234	400NHG2B	400	2	NX400	50	MSMI06
30	225	300	360	207.9	LC1E250	LC1E250	LC1E160	LRE484	146-234	400NHG2B	400	2	NX400	50	MSMI06
31	250	335	435	251.2	LC1E300	LC1E300	LC1E200	LRE485	174-279	450NHG3B	450	3	NX630	50	MSMI06
32	275	370	440	254.0	LC1E300	LC1E300	LC1E200	LRE485	174-279	450NHG3B	450	3	NX630	50	MSMI06
33	315	425	548	316.4	LC1E400	LC1E400	LC1E250	LRE486	208-333	630NHG3B	630	3	NX630	50	MSMI06
34	335	452	580	334.9	LC1E400	LC1E400	LC1E250	LRE487	258-414	630NHG3B	630	3	NX630	50	MSMI06
35	355	475	618	356.8	LC1E400	LC1E400	LC1E250	LRE487	258-414	630NHG3B	630	3	NX630	50	MSMI06
36	375	502	653	377.0	LC1E400	LC1E400	LC1E250	LRE487	258-414	800NHG3B	800	3	NA	50	MSMI06
37	400	535	674	389.1	LC1E500	LC1E500	LC1E300	LRE487	258-414	800NHG3B	800	3	NA	200	MSMI06

* Relay can match with contactor electrically (i.e Cannot be directly mounted), rest all relays are suitable for direct mounting as per catalogue. Use alternate suggested for direct mounting.

**Selection valid upto Trip class 10/10A, Contact nearest sales office for details of EOCR to be used with this selection charts.

For guaranteed performance, Motor feeders built using this chart must make use of MSMI06 or equivalent Schneider Electric make timer only.

Selection Chart

Direct-on-Line starters with circuit-breaker type CVS and overload protection by separate overload relay type LRE (thermal) or EOCR** (up to Trip class 10/10A)

Reliable
switching for
IE2/IE3 motors



IE2



IE3

Rated Operational Voltage, $U_e = 400/415V, 50/60Hz$
Short Circuit Current $I_q = 50kA$

Type-2 Recommended Selection

Sr. No.	3Φ Motors			Contactor	Overload Relay		Circuit Breaker			
	kW	HP	FLC - I_n (Amps)		Type	Range (A)	Type	Trip Unit Rating	Magnetic Setting Range	Setting on Trip Unit in Amps
1	0.37	0.5	1.4	LC1E09	LRE06	1-1.6	CVS100-MA	2.5	6-14	15
2	0.55	0.75	1.7	LC1E09	LRE07	1.6-2.5	CVS100-MA	2.5	6-14	17.5
3	0.75	1	2.2	LC1E09	LRE07	1.6-2.5	CVS100-MA	2.5	6-14	22.5
4	1.1	1.5	2.9	LC1E09	LRE08	2.5-4	CVS100-MA	6.3	6-14	31.5
5	1.3	1.75	3	LC1E09	LRE08	2.5-4	CVS100-MA	6.3	6-14	31.5
6	1.5	2	3.8	LC1E09	LRE08	2.5-4	CVS100-MA	6.3	6-14	37.8
7	2.2	3	5.1	LC1E18	LRE10	4-6	CVS100-MA	6.3	6-14	63
8	3	4	6	LC1E18	LRE10	4-6	CVS100-MA	6.3	6-14	69.3
9	3.7	5	8.1	LC1E25	LRE14	7-10	CVS100-MA	12.5	6-14	100
10	4	5.5	8.5	LC1E25	LRE14	7-10	CVS100-MA	12.5	6-14	100
11	5.5	7.5	11.4	LC1E32	LRE16	9-13	CVS100-MA	12.5	6-14	137.5
12	7.5	10	15.4	LC1E32	LRE21	12-18	CVS100-MA	25	6-14	175
13	9.3	12.5	17.3	LC1E32	LRE21	12-18	CVS100-MA	25	6-14	200
14	11	15	22	LC1E40B	LRE22	16-24	CVS100-MA	25	6-14	275
15	13	17.5	24	LC1E40B	LRE22	16-24	CVS100-MA	25	6-14	300
16	15	20	30	LC1E50	LRE32* or LRE353	23-32	CVS100-MA	50	6-14	350
17	18.5	25	36	LC1E65	LRE35* or LRE355	30-38* 30-40	CVS100-MA	50	6-14	450
18	22	30	43	LC1E65	LRE357	37-50	CVS100-MA	50	6-14	500
19	30	40	56	LC1E80	LRE359	48-65	CVS100-MA	100	6-14	700
20	37	50	69	LC1E95	LRE361	55-70	CVS100-MA	100	6-14	800
21	45	60	84	LC1E120	LRE482	84-135	CVS100-MA	100	6-14	1000
22	55	75	99	LC1E160	LRE482	84-135	CVS100-MA	100	6-14	1200
23	75	100	134	LC1E160	LRE482	84-135	CVS250-MA	150	9-14	1650
24	80	110	139	LC1E160	LRE483	124-198	CVS250-MA	150	9-14	1650
25	90	120	164	LC1E200	LRE483	124-198	CVS250-MA	220	9-14	1980
26	110	150	204	LC1E250	LRE484	146-234	CVS250-MA	220	9-14	2420
27	125	170	234	LC1E300	LRE484	146-234	CVS400-MA	320	6-13	2880
28	132	180	247	LC1E300	LRE485	174-279	CVS400-MA	320	6-13	3200
29	160	215	288	LC1E400	LRE486	208-333	CVS400-MA	320	6-13	3520
30	180	240	298	LC1E400	LRE486	208-333	CVS400-MA	320	6-13	3520
31	200	270	348	LC1E400	LRE487	258-414	CVS630-MA	500	6-13	4500
32	225	300	360	LC1E500	LRE487* or LRE488	258-414* 321-513	CVS630-MA	500	6-13	4500
33	250	335	435	LC1E500	LRE488	321-513	CVS630-MA	500	6-13	5500
34	275	370	440	LC1E630	LRE489	394-630	CVS630-MA	500	6-13	5500
35	315	425	548	LC1E630	LRE489	394-630	CVS630-ETS	630	2-10	6300
36	335	452	580	LC1E630	LRE489	394-630	CVS630-ETS	630	2-10	6300
37	355	475	618	LC1E630	LRE489	394-630	CVS800-TMD	800	3.5-10	8000

* Relay can match with contactor electrically (i.e Cannot be directly mounted), rest all relays are suitable for direct mounting as per catalogue. Use alternate suggested for direct mounting.

** Selection valid upto Trip class 10/10A, Contact nearest sales office for details of EOCR to be used with this selection charts.

Selection Chart

Star Delta starters with circuit-breaker type CVS and overload protection by separate overload relay type LRE (thermal) or EOCR** (up to Trip class 10/10A)

Reliable
switching for
IE2/IE3 motors



IE2



IE3

Rated Operational Voltage, $U_e = 400/415V, 50/60Hz$
Short Circuit Current $I_q = 50kA$

Type-2 Recommended Selection

Sr. No.	3Φ Motors				Contactor			Overload Relay		Circuit Breaker				Minimum Pause time (mSec)	Star-Delta Timer#
	kW	HP	FLC - I_n (Amps)					Type	Range (A)	Type	Trip Unit Rating	Mag-netic Setting Range	Setting on Trip Unit in Amps		
			Line	Phase	Main	Delta	Star								
1	0.75	1	2.2	1.3	LC1E09	LC1E09	LC1E09	LRE06	1-1.6	CVS100-MA	6.3	6-14	37.8	50	MSMI06
2	1.1	1.5	2.9	1.7	LC1E09	LC1E09	LC1E09	LRE07	1.6-2.5	CVS100-MA	6.3	6-14	50.4	50	MSMI06
3	1.3	1.8	3	1.7	LC1E09	LC1E09	LC1E09	LRE07	1.6-2.5	CVS100-MA	6.3	6-14	50.4	50	MSMI06
4	1.5	2	3.8	2.2	LC1E09	LC1E09	LC1E09	LRE07	1.6-2.5	CVS100-MA	6.3	6-14	63	50	MSMI06
5	2.2	3	5.1	2.9	LC1E09	LC1E09	LC1E09	LRE08	2.5-4	CVS100-MA	12.5	6-14	100	50	MSMI06
6	3	4	6	3.5	LC1E09	LC1E09	LC1E09	LRE08	2.5-4	CVS100-MA	12.5	6-14	112.5	50	MSMI06
7	3.7	5	8.1	4.7	LC1E09	LC1E09	LC1E09	LRE10	4-6	CVS100-MA	12.5	6-14	150	50	MSMI06
8	4	5.5	8.5	4.9	LC1E09	LC1E09	LC1E09	LRE10	4-6	CVS100-MA	12.5	6-14	162.5	50	MSMI06
9	5.5	7.5	11.4	6.6	LC1E12	LC1E12	LC1E09	LRE12	5.5-8	CVS100-MA	25	6-14	225	50	MSMI06
10	7.5	10	15.4	8.9	LC1E18	LC1E18	LC1E09	LRE14	7-10	CVS100-MA	25	6-14	300	50	MSMI06
11	9.3	13	17.3	10	LC1E25	LC1E25	LC1E12	LRE14	7-10	CVS100-MA	25	6-14	325	50	MSMI06
12	11	15	22	12.7	LC1E25	LC1E25	LC1E12	LRE16	9-13	CVS100-MA	50	6-14	400	50	MSMI06
13	13	18	24	13.9	LC1E32	LC1E32	LC1E12	LRE21	12-18	CVS100-MA	50	6-14	450	50	MSMI06
14	15	20	30	17.3	LC1E32	LC1E32	LC1E18	LRE21	12-18	CVS100-MA	50	6-14	550	50	MSMI06
15	18.5	25	36	20.8	LC1E40B	LC1E40B	LC1E25	LRE22	16-24	CVS100-MA	50	6-14	700	50	MSMI06
16	22	30	43	24.8	LC1E40	LC1E40	LC1E32	LRE32* or LRE353	23-32	CVS100-MA	100	6-14	800	50	MSMI06
17	30	40	56	32.3	LC1E50	LC1E50	LC1E38	LRE355	30-40	CVS100-MA	100	6-14	1100	50	MSMI06
18	37	50	69	39.8	LC1E65	LC1E65	LC1E40	LRE355	30-40	CVS100-MA	100	6-14	1300	50	MSMI06
19	45	60	84	48.5	LC1E80	LC1E80	LC1E50	LRE357	37-50	CVS250-MA	150	9-14	1650	50	MSMI06
20	55	75	99	57.2	LC1E95	LC1E95	LC1E65	LRE359	48-65	CVS250-MA	150	9-14	1950	50	MSMI06
21	75	100	134	77.4	LC1E120	LC1E120	LC1E80	LRE481	62-99	CVS250-MA	220	9-14	2640	50	MSMI06
22	80	110	139	80.3	LC1E120	LC1E120	LC1E80	LRE481	62-99	CVS250-MA	220	9-14	2640	50	MSMI06
23	90	120	164	94.7	LC1E160	LC1E160	LC1E95	LRE482	84-135	CVS250-MA	220	9-14	3080	50	MSMI06
24	110	150	204	117.8	LC1E200	LC1E200	LC1E120	LRE482*	84-135	CVS400-MA	320	6-13	3840	50	MSMI06
25	125	170	234	135.1	LC1E250	LC1E250	LC1E120	LRE483*	124-198	CVS630-MA	500	6-13	4500	50	MSMI06
26	132	180	247	142.6	LC1E250	LC1E250	LC1E120	LRE483*	124-198	CVS630-MA	500	6-13	5000	50	MSMI06
27	150	200	248	143.2	LC1E250	LC1E250	LC1E120	LRE483*	124-198	CVS630-MA	500	6-13	5000	50	MSMI06
28	160	215	288	166.3	LC1E300	LC1E300	LC1E160	LRE483*	124-198	CVS630-MA	500	6-13	5500	50	MSMI06
29	180	240	298	172.1	LC1E300	LC1E300	LC1E160	LRE483*	124-198	CVS630-MA	500	6-13	6000	50	MSMI06
30	200	270	348	200.9	LC1E400	LC1E400	LC1E200	LRE484	146-234	CVS630-MA	500	6-13	6500	50	MSMI06
31	225	300	360	207.9	LC1E400	LC1E400	LC1E200	LRE484	146-234	CVS630-MA	500	6-13	6500	50	MSMI06
32	250	335	435	251.2	LC1E400	LC1E400	LC1E250	LRE485	174-279	CVS630-MA	500	6-13	6500	50	MSMI06
33	275	370	440	254	LC1E400	LC1E400	LC1E250	LRE485	174-279	CVS630-MA	500	6-13	6500	50	MSMI06
34	315	425	548	316.4	LC1E500	LC1E500	LC1E300	LRE486*	208-333	CV630-ETS	630	2-10	6300	200	MSMI06

* Relay can match with contactor electrically (i.e Cannot be directly mounted), rest all relays are suitable for direct mounting as per catalogue. Use alternate suggested for direct mounting.

**Selection valid upto Trip class 10/10A, Contact nearest sales office for details of EOCR to be used with this selection charts.

For guaranteed performance, Motor feeders built using this chart must make use of MSMI06 or equivalent Schneider Electric make timer only.

Life Is 

Schneider
Electric

Schneider Electric India Pvt. Ltd.

Corporate Office: 9th Floor, DLF Building No. 10, Tower C, DLF Cyber City, Phase II, Gurugram 122002 Haryana
Tel.: ++91 124 6899000 Fax: ++91 124 4222036/037

Ahmedabad

Schneider Electric India (P) Ltd.
1506-1507, 15th Floor Shapth-5
Opp.Karnavati Club, SG Highway,
Ahmedabad, Gujarat - 380015
Tel.: 079-66826701

Coimbatore

Schneider Electric India (P) Ltd.
Hanudev Info Tech Park, 6th Floor
Unit No. Block-C, SF No. 558/2
Udalyampalayam Road, Nava India
Coimbatore-641028

Lucknow

Schneider Electric India (P) Ltd.
Summit, Plot No. TCG 3/3
6th Floor, 604A/B/C, Vibhuti Khand
Gomti Nagar, Lucknow
Uttar Pradesh - 226010
Tel.: 0522-3500334

Nashik

Schneider Electric India (P) Ltd.
401, 4th Floor, Rishi Raj Towers
Jehan Circle, Gangapur Road
Nashik- 422013
Tel.: 0253-2344333

Bengaluru

Schneider Electric India (P) Ltd.
No. 3/1, JP Techno Park
Mezzanine Floor, Millers Tank Bund
Road, Vasanth Nagar
Bengaluru - 560052
Tel.: 080-71481351

Hyderabad

Schneider Electric India (P) Ltd.
D.No. 1-8-271, # 401, Ashoka
Bhoopal Chambers, SP Road
Secunderabad - 500003
Tel.: 040-67219500

Ludhiana

Schneider Electric India (P) Ltd.
SCO 23, 2nd Floor,
Chandigarh Road, Sector 32
Ludhiana, Punjab-141010
Tel.: 0161- 5203011

New Delhi

Schneider Electric India (P) Ltd.
C-56, Mayapuri Industrial Area, Phase-2
New Delhi - 110064
Tel.: 011-61317400

Bhubaneswar

Schneider Electric India (P) Ltd.
Workloop Co-Working in the property
Office No. 316, Esplanade One Mall
Rasulgarh, Bhubaneswar - 751010

Indore

Schneider Electric India (P) Ltd.
219, Dhan Trident Building
Vijay Nagar, A.B.Road
Indore-452001

Mohali

Schneider Electric India (P) Ltd.
2nd Floor, Tower-A
Bestech Business Tower
Mega Information & Technology Park
Industrial Plot No.1, Phase IX
(Expansion), Mohali- 160059
Tel.: 0172-7198200

Pune

Schneider Electric India (P) Ltd.
Amar Caliber, CTS No 911, BMCC Road,
OFF FC. Road, Deccan Gymkhana,
Shivaji Nagar, Pune - 411007
Tel.: 020-67492500

Chennai

Schneider Electric India (P) Ltd.
No: 29, 2nd Floor,
Bannari Amman Towers, B-Block
Dr. Radhakrishnan Road, Mylapore
Chennai - 600 004
Tel.:044-71912000

Jaipur

Schneider Electric India (P) Ltd.
Jaipur Business Centre 309
3rd Floor, Sangam Tower 190
Church Road, Jaipur-302001
Tel.: 0141-2374810

Mumbai

Schneider Electric India (P)(Ltd)
Marwah House, 2nd Floor
Krishanlal Marwah Marg
Andheri (East), Mumbai - 400072
Tel.: 022-62280000

Vadodara

Schneider Electric India (P) Ltd.
Notus IT Park, 10th Floor, Block-D
Sarabhai Campus, Vadiwadi
Vadodara, Gujarat - 390017

Cochin

Schneider Electric India (P) Ltd.
Alapatt Properties Private Limited
(Trade Name : Centre A)
Main Door Number : 66/4971
(Old Door Number: 40/6584-H)
7th Floor Alapatt Heritage Building
MG Road Kochi - 682035

Kolkata

Schneider Electric (I)Pvt.Ltd,
BP-4, Sector-V, Technopolis
3rd Floor, Salt Lake City
Kolkata- 700 091
Tel.: 033-66576400

Nagpur

Schneider Electric India (P) Ltd.
6, Vasant Vihar Complex
W.H.C Road, Shankar Nagar
Nagpur- 440010
Tel.: 0712-2558581

Vishakhapatnam

Schneider Electric India (P) Ltd.
D.N.10-1-43, 1st Floor
Ratnam's Business Centre,
Siripuram Fort, C.B.M.Compound
Visakhapatnam - 530016
Tel.: 0891-6675500

Customer Care Centre

Monday-Saturday, 9 a.m. to 8 p.m.

Toll-free numbers: 1800 419 4272, 1800 103 0011

Email: customercare.in@schneider-electric.com

For more information, visit our website at: www.se.com/in

- All Prices are in Indian Rupees
- Prices are subject to change without prior notice
- Product evolution is a continuous process and Schneider Electric reserves the right to modify/withdraw any product at any time without prior notice
- Prices charged will be as prevailing on the date of dispatch
- Invoice Amount = (MRP – less Applicable discount) + Applicable GST %
- Tax incidence on invoices is basis applicable GST rates
- Invoice amount not to exceed MRP
- Product pictures shown are for illustration purpose only, actual product may vary

Distributor